



BUSINESS SIMULATION CASE STUDIES

Supply Chains

Manufacturing

Business Processes

Defense

Oil & Gas

Warehouse
Operations

Healthcare

Transportation

Rail Logistics

Cargo Ports &
Terminals

Passenger Terminals

Marketing



CONTENTS

Introduction.....	03
01 Siemens: Digital Twin of Gas Turbine Fleet Operations.....	04
02 Microsoft: End-To-End Supply Chain Management Solution.....	10
03 CNH Industrial: Digital Twin of a Manufacturing Line.....	16
04 PWC: Major US Airline Decides not to Charge Additional Fees.....	20
05 CCC: Construction Simulation Model for Tackling Increased Constraints.....	24
06 Frankfurt Airport: Passenger Flow Simulation.....	28
07 CSX: Solving Railroad Operation Challenges.....	31
08 Lockheed Martin: Improving Plane Maintenance Process.....	36
09 Transocean: Simulation Based Digital Twin for Well Construction Process Optimization.....	40
10 Goldratt: Improving Reliability and Profitability of Integrated Steel Supply Chain.....	44
11 Le Havre: Internal Rail Logistics Simulation.....	49

12	Cardinal Health: Optimizing Warehouse Operations.....	52
13	YPF: Resource Optimization in the Oil & Gas Industry.....	56
14	REME: Military Aircraft Maintenance Scheduling and Staffing Optimization.....	60
15	Pfizer: Using Predictive Modeling in Healthcare for Simulation of Clinical Trials.....	64
16	Karolinska University Hospital: Simulation of Maternity Ward Operations.....	67
17	Symbotic: Evaluating Introduction of Warehouse Automation Systems.....	70
18	Fruit of the Loom: Choosing Location for New Distribution Center.....	73
19	STREAM: Oil Pipeline Network Design.....	78
	Additional resources.....	81
	Contacts.....	82

INTRODUCTION

AnyLogic software, developed by The AnyLogic Company, provides a single platform for all your business's dynamic simulation modeling needs. It is utilized worldwide by over 40% of Fortune 100 companies.

AnyLogic models enable analysts, engineers, and managers to gain deeper insights and optimize complex systems and processes across a wide range of industries.

- **Multimethod modeling environment**

Develop simulation models using all three modern methods:

- **Discrete event modeling**
- **Agent-based modeling**
- **System Dynamics**

The three methods can be used in any combination to simulate business systems of any complexity

- **Industry-specific libraries**

Make use of a unique suite of industry-specific modeling tools in one package, at no additional cost. They help simulate complex operations in detail in logistics, transportation, rail, manufacturing, oil & gas, health-care, and other business processes and services.

- **Simulation in the cloud**

Apply cloud technologies and transform your simulation model into a decision-support tool for day-to-day operations. With the AnyLogic Cloud secure web platform, run simulation models online, use rich cloud-based experimentation capabilities, collaborate on models, and deliver simulation results fast.

- **Animation and visualization**

Easily design visually attractive simulation models with 2D and 3D animation. The results make concepts and ideas easier to understand, verify and communicate. Dynamic visualization makes complex simulation models self-explanatory.

- **Digital twin development environment**

Build digital replicas of real-world systems using AnyLogic modeling software. Digital twins allow for simulating system behavior, tracking performance metrics, and predicting potential downtime or maintenance needs. AnyLogic digital twins are currently used by industry leaders worldwide.

- **AI and simulation**

Design detailed and robust virtual environments for training and testing AI algorithms using cloud-based models. Once connected with machine learning platforms, models leverage powerful cloud computing, which helps neural networks learn faster and more efficiently.



SIEMENS

DIGITAL TWIN OF GAS TURBINE FLEET OPERATIONS

01

OVERVIEW

As the deployment of Internet of Things (IoT) systems grows, the concept of something physical having a virtual avatar is increasingly important.

Digital twins represent a virtual avatar of a physical system. These digital representations are built using the domain knowledge of subject matter experts as well as data collected from sensors on-board the system.

The Agent-based Turbine Operations & Maintenance (ATOM) model is a digital twin simulation model developed by decisionLab Ltd and Siemens. The digital twin emulates the global maintenance repair and overhaul (MRO) operations of Siemens' aero-derivative gas turbine division. Driven by live data already available within the supply chain, the model provides the capability to use sophisticated simulation and data-analytics methodologies to optimize the fleet operations of Siemens, enabling better data-driven decision-making to improve productivity and efficiency in customer operations and asset management.

PROBLEM

Siemens produces a wide range of industrial turbines and recently acquired the Rolls-Royce energy gas turbine and compressor business. Following this, Siemens introduced a new aero-derivative gas turbine (SGT-A65) based on the acquired assets.

With the new turbine not being wholly developed in house, its production and maintenance produced multiple new challenges, including unforeseen in-service performance and support issues.

The Excel-based forecasting tools used by Siemens at that time failed to perform efficiently under the new circumstances. The volume of data was too much to manage in Excel and the results were not clear enough to easily identify bottlenecks and quickly find solutions.

In short, the company needed a more powerful method for resolving its gas-turbine fleet operation issues. The main needs were to:

- Predict business performance and forecast KPIs of interest to inform decision-making;
- Evaluate investment options – run “what-if” scenarios to quickly understand where best to invest.

Siemens wanted to visualize the whole production and maintenance process, including the supply-chain logistics, which are critical to the system. With the ability to visualize the results of multiple “what-if” scenarios, in order to communicate the business case for several investment options and enable better decision-making, both inside the company and outside, with clients.

SOLUTION

To meet the challenges, decisionLab and Siemens proposed a digital twin - ATOM. The ATOM digital twin exploits the emergence of digital technologies across Siemens engineering and manufacturing businesses. It uses the vast quantities of data that is available to integrate customers, supply chain, production, and maintenance in order to improve productivity and efficiency in customer operations and asset management. At its core

ATOM achieves this by modelling the detailed intricacies of customer operations, maintenance facility operations, engine characteristics, and supply-chain logistics across the whole fleet and operational cycle.

Representing the entire system, the digital twin provides great analytical capabilities. Users can examine any aspect of the system and run what-if scenarios to explore all the interdependencies. Such a system would easily identify bottlenecks and enable decision-making that considers the operation of the system as a whole.

The development of digital twin requires a highly complex simulation environment, and developers will often use a software development approach. This requires great flexibility from the simulation software to successfully model different levels of business processes and manage varying complexity. For this reason, decisionLab chose AnyLogic as the core simulation tool.

In this case, a core part of the model was made from many independent elements and using agent-based modeling it was possible to represent the necessary details. To build the model, the developers captured data relating to the following aspects of Siemens gas turbine fleet operations:

- **Customer operations** (in what conditions, e.g. temperature, customers use the turbines)
- **Maintenance facility operations** (both main maintenance facilities were considered)
- **Engine characteristics** (different failure modes associated with particular engine components)



- **Supply-chain logistics** (as customers are located all over the world)

This is represented in the agent interaction diagram, which defines the complexity of the digital twin environment.

In addition to the agent-based modelling approach, the digital twin incorporated a modular architecture, which allowed the system to be

divided virtually into its constituent functional layers and provide a system engineering-based approach to model development. This approach allows concurrent users to interact with the model in different ways, and to use different data sets, and also enable the development team to adopt a continuous development and deployment approach without disruption – a reinforcement learning element is planned.

In collaboration with Siemens future phases of development could include the following:

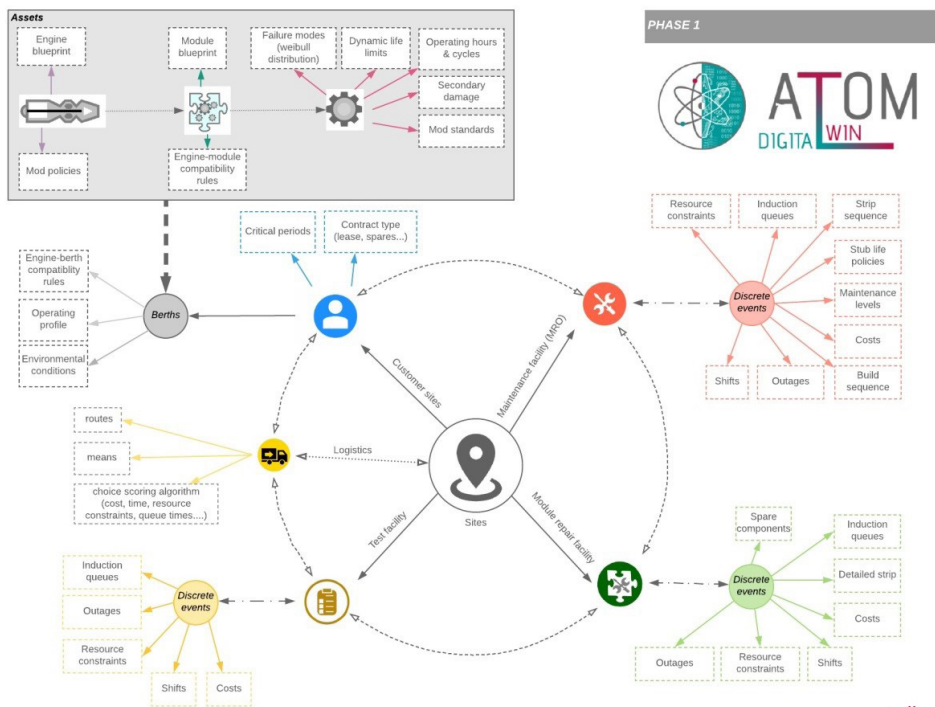

AGENT INTERACTION DIAGRAM

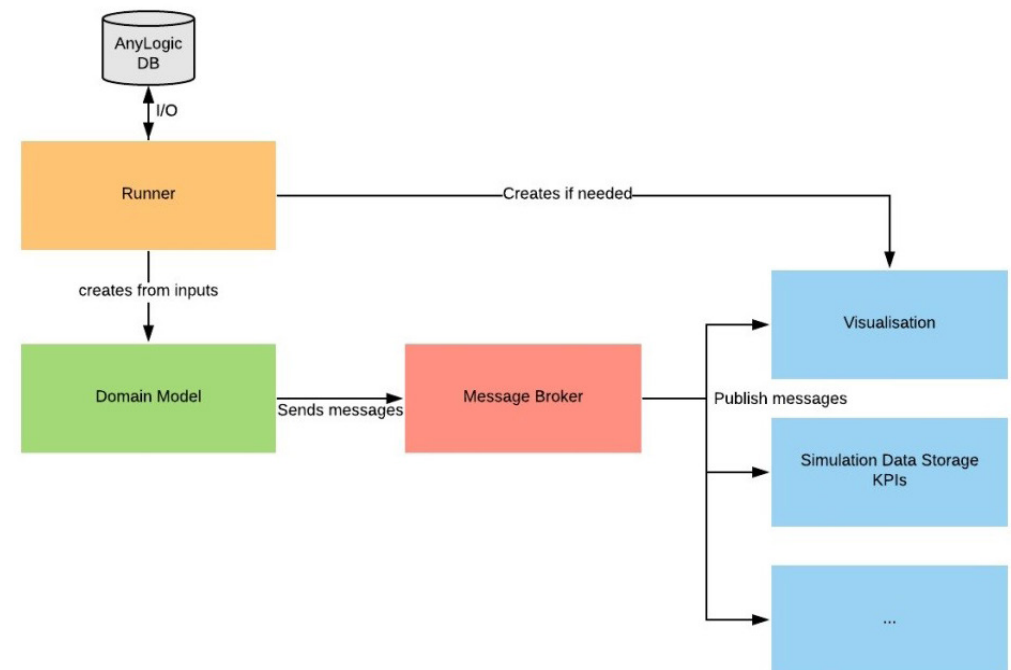

A MODULAR ARCHITECTURE OF THE DIGITAL TWIN

- To move from an Excel database to a centralized database containing all Siemens systems and databases, for optimized data storage and processing;
- To deploy the model in the cloud, so multiple users can access it;
- To make it possible to use ATOM as a demonstration tool, for work with customers (i.e. to continue improving the visualization part);
- To add a reinforcement learning capability to optimize the dynamic decision-making process within the simulation environment and present an optimal policy that Siemens might adopt business investment decisions.

OUTCOME

DecisionLab have created a sophisticated digital twin that captures all the functionality required by Siemens. The ATOM-twin simulation model, representing the entire fleet operations of Siemens aero-derivative gas turbines, enables its users to:

- capture and forecast system KPIs
- visualize fleet and maintenance facility operations
- identify bottlenecks in the system

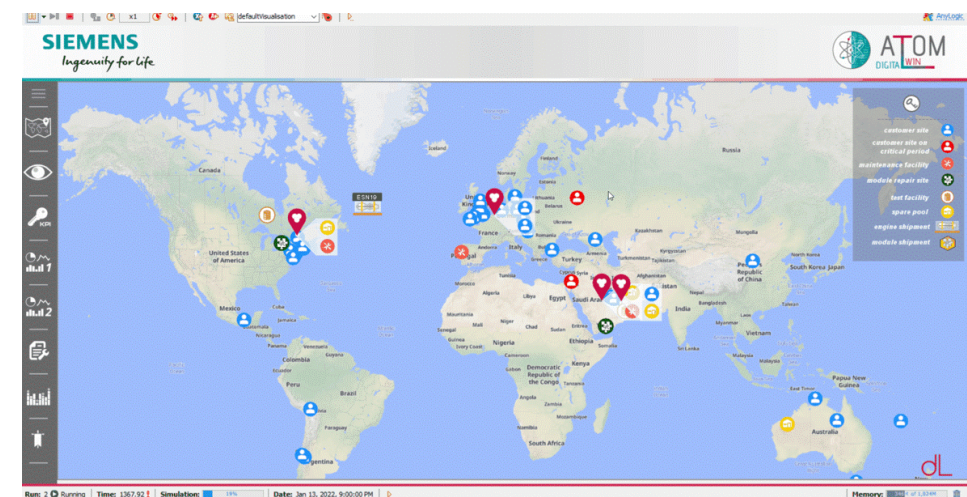
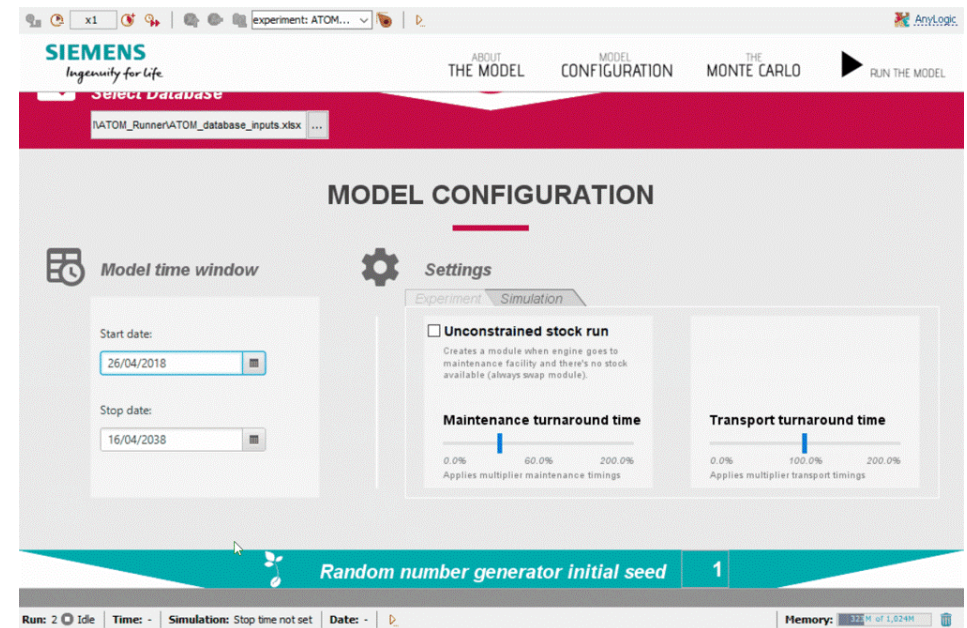

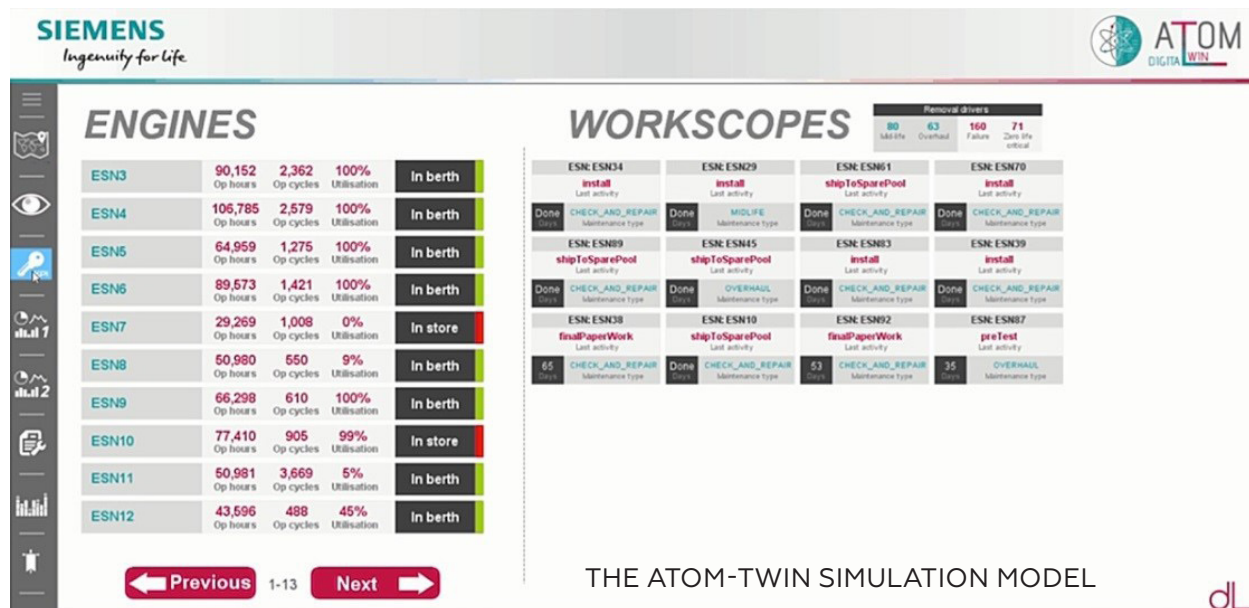

- run both quick 'what-if' and detailed scenarios to aid investment decision-making

[Read case study online](#)
[Watch case study presentation video](#)

Although a very complex simulation model, decisionLab delivered a user-friendly and interactive system, usable across the organization. Both upper-management and analysts can use ATOM to easily meet their needs.



MICROSOFT

END-TO-END SUPPLY CHAIN
MANAGEMENT SOLUTION

PROBLEM

Microsoft is one of the largest tech companies in the world, with a sales revenue of over 90 billion US dollars. More and more of its sales revenue now come from selling physical devices, and this exposes the company to an accompanying level of complexity and uncertainty. The company has over 30,000 products with a large variation in life cycles, more than 600 suppliers, 13 contract manufacturers, and 52 distribution centers distributing products into 191 countries.

In 2015, Goldratt Research Labs was contracted by Microsoft to design, validate, pilot and implement an end-to-end Supply Chain Management solution based on Theory of Constraints (TOC) best practices. This

formed part of Microsoft's "One Devices Supply Chain" (1DSC) solution designed to achieve:

- One set of Planning, Execution and Improvement rules for managing all products and order fulfillment strategies within Microsoft's supply chain.
- One system (SAP) in which to implement these rules.

A critical part of the project was for Goldratt Research Labs to develop a self-configurable Supply Chain simulation model using AnyLogic to validate the likely operational and financial improvements that would be achieved from the TOC based solution design before going live.

PROJECT DEVELOPER

Dr. Alan Barnard and his Goldratt Research Labs (GRL) simulation team lead by Dr. Andrey Malykhanov are very passionate about helping organizations answer two simple but important questions: "How much better can you do?" and "How best to do it?". They work with leading organizations from around the globe, in both private and public sectors, among them: BHP Billiton, Cargill, TATA Steel, ABB, Daiwa House, Utah Gov., and Larsen & Toubro.

GRL uses robust research methods and advanced technologies like Simulation modeling, Artificial Intelligence and Expert Systems to identify how much better organizations can do if they switched from "local optima" to the "global optima" rules of Theory of Constraints (TOC). GRL is also a spearhead for new TOC based research and development, to develop new knowledge and applications of the ever-growing TOC body of knowledge.



What is Theory of Constraints (TOC)?

According to Dr. Barnard, Theory of Constraints is called “a theory” for a good reason. Kurt Lewin (1890 –1947) one of the pioneers in organizational psychology famously said that “There is nothing as practical as a good theory”. In Science, we call something a “theory” if it provides a good explanation of why something is important and useful. Theory of Constraints, as a Theory of Management, explains why knowledge of a System’s constraint, is important and useful in helping managers make five challenging decisions in any complex system:

- **How to define ambitious but achievable goals?** Knowing the constraint of a system determines the theoretical maximum this system can produce.
- **How to decide where to focus?** The real constraint in any social system is limited management attention simply because the demand on our attention will always exceed our available attention available. Knowing where the constraint is in a system helps managers decide where to focus their limited attention to achieve more with less in less time.
- **How to judge the system impact of changes?** Knowing the impact of a change on the system constraint provides a “shortcut” for judging the impact of any changes on the whole system.
- **How to decide what rules to use?** In turns out that the rules needed to optimize a system constraint — making sure that the constraint is never blocked, starved, overproducing, or wasting

capacity in other ways is also the rules to optimize the performance of the whole system.

- **How to decide when to change the rules?** If the constraint moves, the rules must change. If you have a production constraint, then running long batches on the bottleneck machine to save setups make sense. But when the constraint moves to the market, this rule has to be changed to ensure capacity is not wasted or sales lost producing things the market don’t want.

Theory of Constraints creator, Dr. Eli Goldratt, and TOC practitioners like Dr. Barnard and his team from GRL, has over the past 30 years, identified a number of often counter-intuitive but global optima rules that can result in step-change improvements in managing operations, supply chains and project environments.

A number of these TOC best practice rules for managing supply chains was used in the core design of the Microsoft end-to-end SCM solution and additional innovations in Supply Chain planning and execution was developed to cater for unique complexities within the Microsoft landscape.

PROJECT DESCRIPTION

The project started in September 2015. The Theory of Constraints principles and best practices were used by GRL to design a world-class supply chain for Microsoft. During the pilot stage, the Theory of Constraints based SCM rules were tested in an AnyLogic simulation model to validate that it will result in better operational and financial performance (e.g. less shortages

and surpluses resulting in more revenue, higher profitability with lower inventory). By mid-December 2015, the first set of TOC derived rules for Build-to-Order (BTO) went live within Microsoft’s SAP system. In 2016, additional rules for Build-to-Availability (BTA), “Assemble or Customize-to-Order” (ATO) and “Build-to-X” (BTX) were tested in implemented. The whole project was finished in less than 9 months.

SOLUTION

A Strategy-and-Tactic tree (S&T Tree) was developed to show exactly what rules were required to achieve the desired performance improvement and objectives of the 1DSC initiative. As per figure below, six rules needed to be changed:

- **Order fulfillment strategy:** should it be make-to-order (BTO), assemble-to-order (ATO), make-to-availability (BTA), or build-to-X(where X is launch target quantity) (BTX).
- **ATO/BTO buffering:** how to quote reliable lead times to BTO/ATO customers.
- **BTA/BTX buffering:** how to ensure we have sufficient stock of parts and finished goods.
- **Release control:** how to control the release of BTO/ATO, BTX and BTA orders.
- **Shared priority:** how to achieve a Single Priority System throughout supply chain.

- **Improve flow:** how to systematically improve flow.
- **With the S&T Tree, the Why, What and How** of each of these rules were defined to help all stakeholders understand the assumptions behind the rules and to find the simplest way to implement these within standard SAP.

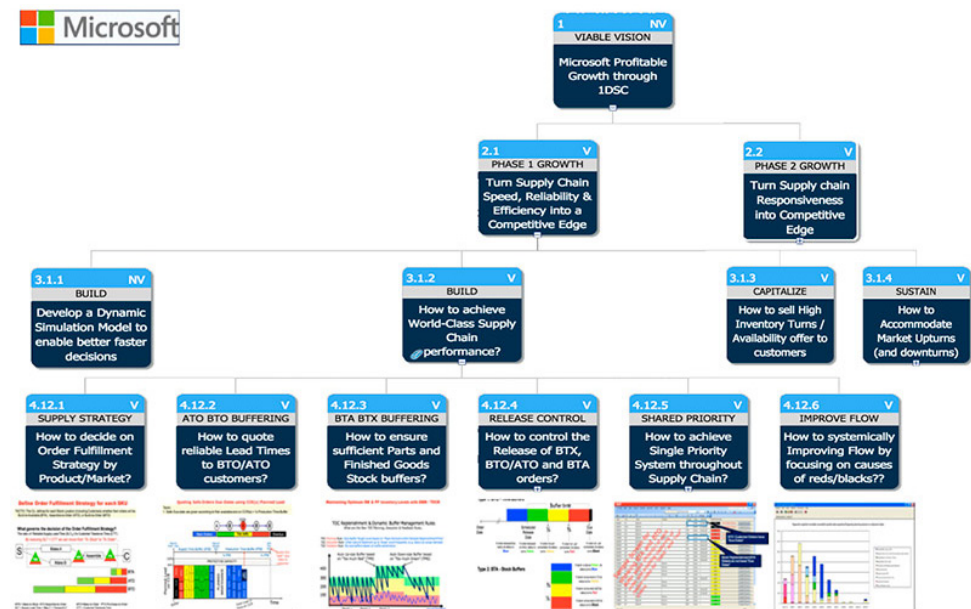

DESIGNING TOC-BASED SCM SOLUTION

The AnyLogic simulation model that was developed to test and verify the operational and financial performance of the new rules.

Supply Chain and Product Data is extracted from the SAP system into an Excel file to fully model and configure the Microsoft global supply chain. Additionally, data of actual customer demand and actual daily on-hand-stock over the modeling period were extracted to allow the model to compare simulated (using the new TOC-based rules) vs. actual past performance.

Randomness was introduced in the model by the Supply chain planning team around such things as variability in production cycle times and distribution supply lead time. Also, information on random events such as planned and unplanned maintenance as well as the impact of positive and negative demand forecast error can be integrated to stress-test the Microsoft supply chain.

The AnyLogic custom model was designed to have a simple user interface to allow stakeholders to manage the scenarios and select the TOC rules to use, the simulation time period, product-channels to include or exclude when running the model without any knowledge of AnyLogic. The output of the simulation is visible directly from the AnyLogic model and can also be exported to Excel. Should results not meet expectations, extensive logs are created to help with diagnostics.

The model can be run in three different ways:

- Single run experiment

- Sensitivity analysis to test how sensitive certain parameters are to the outcomes.
- Scenario comparison

Creating a Self-configurable Simulation model from SAP data

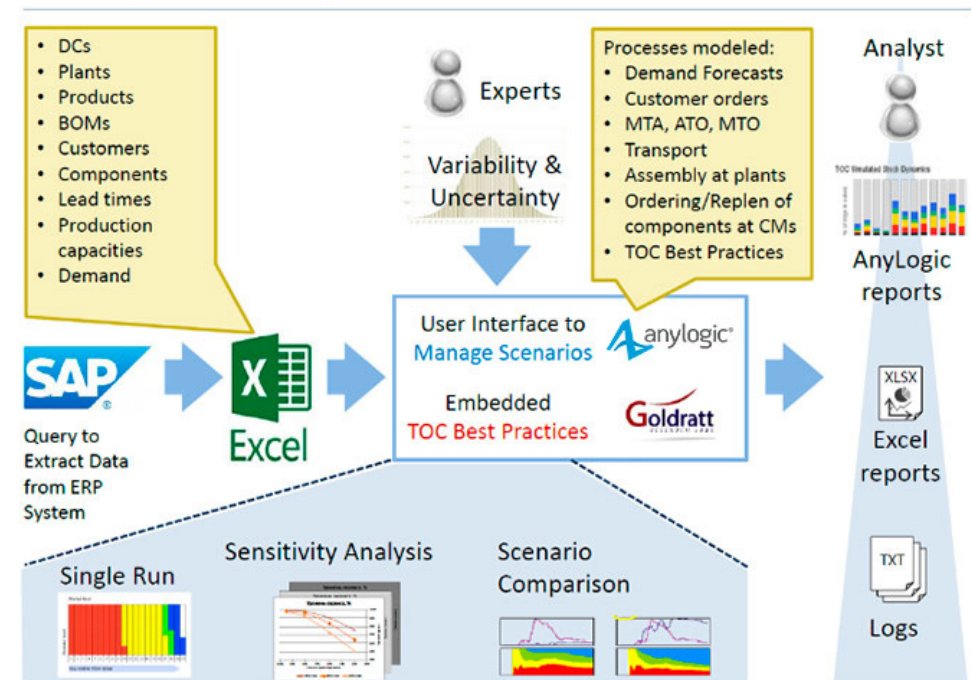

PROJECT BASIC ARCHITECTURE

The AnyLogic model setup user interface includes network flow and world map to visualize the supply chain configuration for which data was imported, the product categories as well as Replenishment types. Users



can view cumulative plots of actual vs. forecast demand vs. production capacity to get a sense of possible issues and users have the ability to use both actual demand forecast and customer orders or to generate forecasts from actual orders or orders from forecasts with a predefined positive or negative forecast error to test how the supply chain will cope with demand that is significantly more or less than expected.

During the running of the simulation model, users can view the operational and financial performance and zoom into specific parts, such as a contract manufacturer to see if backlogs are developing and compare simulated vs. actual stock-on-hand for any specific DC and any specific product to show the benefit of using the TOC rules.

Users can “zoom” into a specific DC and a specific product in that DC to see how the TOC-based rules for managing inventory that dynamically resizes the Target Stock Levels based on “too much red” and “too much green” buffer zone penetration performed against past actual daily stock-on-hand.

OUTCOME

Microsoft’s CTO of Global Supply Chain, Robert Meshew, [confirmed](#) the incredible results they have achieved since implementing the new TOC-based end-to-end Supply Chain Solution into their SAP system. “The outcome has been nothing short of remarkable. In that time, we’ve seen our service levels rise to our customers by over 5%. At the same time, we’ve seen our inventory levels drop by quarter billion dollars across the board which has led to reduced markdowns and reduced excess and obsolescence of over a hundred million dollars”.

Using the capabilities of AnyLogic, offered a fast, low cost and low risk way to validate and stress-test the Theory of Constraints based end-to-end Supply Chain solution design.

The next stage of this project will be to work closely with the Microsoft team lead by Manohar Madhira integrate the model into the company’s Sales and Operations planning process as well as to enhance its functionality to be used for “What’s ifs” related to Global Product Launch to support better faster analytics and management decisions.



[Read case study online](#)

[Watch case study presentation video](#)



DIGITAL TWIN OF A
MANUFACTURING LINE

03

OVERVIEW

HOW AND WHY A DIGITAL TWIN WAS CREATED AND TESTED FOR AN AUTOMOTIVE PRODUCTION LINE

CNH Industrial is a global leader in capital goods. It is financially controlled by the Italian investment company Exor and is comprised of 12 brands, including Case, New Holland, and Iveco. Through its brands, CNHi designs, produces, and sells a wide range of agricultural, industrial, and commercial vehicles and powertrains. It employs more than 63,000 people in 66 manufacturing plants and 53 research and development centers in 180 countries. The company is listed on the New York Stock Exchange and is a constituent of the Italian stock market index.

Fair Dynamics operates primarily out of Milan and provides a wide range of consulting services in a variety of industries, including banking, manufacturing, and public services. The company has recently been acquired by Engineering Ingegneria Informatica S.p.A., a provider of software and IT services, both in Italy and internationally. In 2017, the consolidated revenue was more than €1bn.

Fair Dynamics applies innovative technologies to solve industrial problems and improve efficiency. Their key approach is modeling and simulation, for which, the company has been using the AnyLogic Platform since 2010 and is also its Italian distributor.

PROBLEM

Manufacturing processes are becoming increasingly digital. It is considered that now we are entering a fourth industrial era (Industry 4.0) and the transition towards smart factories has begun. Within smart factories,

cyber-physical systems monitor physical processes, create a virtual copy of the physical world, and make decentralized decisions. Digital twins are core to the operation of these systems.

With digitalization already underway, many companies are trying out new technologies like artificial intelligence and cloud computing with the aim of gradually shifting to a smart factory and benefitting from the new phenomena.

CNH Industrial identified maintenance processes as a promising area to start applying new Industry 4.0 technologies.

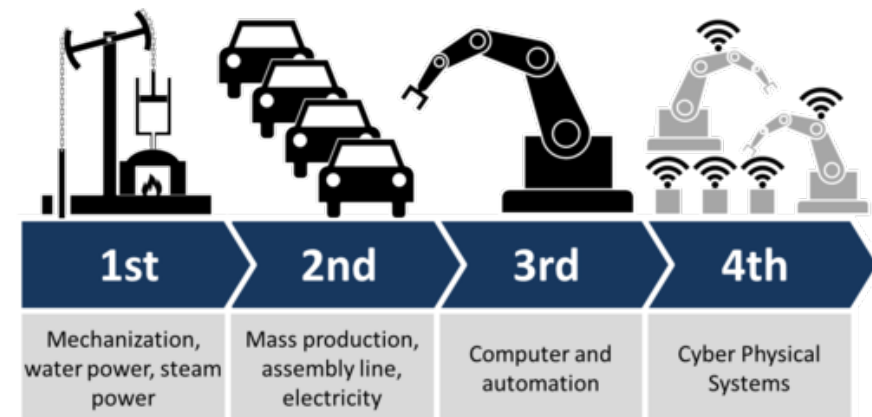

In the automotive and related industries, downtime costs can be large. For global companies like CNHi the cost of a single minute of downtime could be more than \$160k and these figures increase year by year. As such, improving maintenance in order to reduce downtime can deliver significant success. By identifying the most critical areas, even a very small percentage improvement could save a lot of money.

Thus, CNH Industrial wanted to test a digital tool for evaluating and selecting different maintenance policies and agreed with Fair Dynamics on a pilot project. They decided to focus on a single manufacturing line dealing with Iveco Daily van chassis welding (the Mascherone line of the Suzzara plant, Italy). A digital twin, a representation of the line in a virtual environment, was to be created. The simulation would enable CNHi management to see the benefits of possible maintenance policies in various scenarios and make informed maintenance decisions.

The choice of the Suzzara plant for a digital twin was not random. CNH Industrial applies the principles of World Class Manufacturing (WCM), an innovative program for continuous improvement. At that time, CHNi had only one WCM Gold Level award and the Iveco plant in Suzzara was very close to a second one. CNHi wanted to see how the new technology could help attain it.

SOLUTION

The digital twin project focused on a specific manufacturing line, Iveco van chassis welding. This line can be described as a conveyor which runs through a number of stations. Fair Dynamics were asked to focus their attention on the automatic welding stations (orange blocks in the picture). When a van stops at one of these stations, the robots work in unison to complete the welding.

The welding guns have an Achilles heel – the Lamellar pack (an electrical conductor which must flex during operation). The movement gradually leads to the damage of a pack's copper layers. When the damage becomes critical, and sufficiently changes the conductivity, it can result in the

melting of the Lamellar pack itself. While normally this component can be replaced in few minutes, it can take hours if the Lamellar pack has been damaged. A digital twin that monitors and forecasts the health of this component could provide significant downtime reduction.

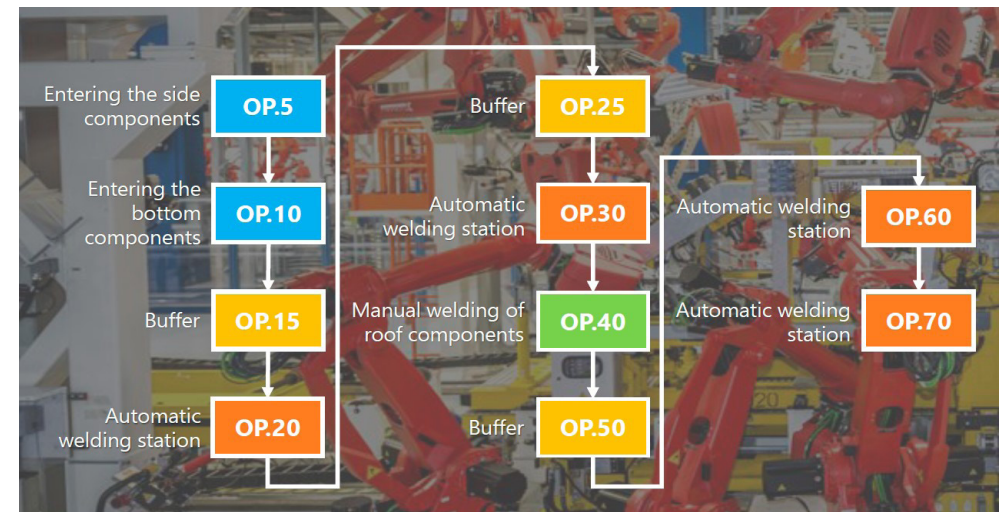

WELDING LINE

Fair Dynamics built an agent-based digital twin with the following agents:

- **Vans** – There are different types of van agents in accordance with the types of vans to be produced. Each type requires different handling (different operations, stations, and robots could be involved) and this affects component degradation.

- **Stations** — Each station agent is characterized by the number of robots it contains and is regulated by particular rules.
- **Robots** — Each robot is fitted with a sensor which sends a signal about the robot's actual condition to the simulation model. Each robot agent, in turn, is provided with a specific PHM (Prognostic & Health Management) model predicting the robot degradation in accordance with the signals received.

By building the digital twin this way, Fair Dynamics could introduce three basic maintenance policies for testing and use:

- **Scheduled maintenance** (components are replaced according to a schedule).
- **Condition-based maintenance** (components are replaced according to warning signals).
- **Predictive maintenance** (components are replaced on a schedule based on information from their state and use).

Within the project, AnyLogic software proved useful for digital twin creation. Apart from enabling agent-based modeling, it enabled the customization that made it possible for Fair Dynamics to include the prognostic ELF (machine learning) model. The integration of modeling and machine learning techniques has great potential in such systems.

Through the use of AnyLogic, the digital twin could connect to external data sources. The production sequence, welding point per van type, robot life cycle curve, and other data were imported from external sources and automatically read by an agent at runtime. Moreover, the system could be exported and delivered as a standalone application to multiple machines, easing data constraints and the demands on the IT department.

OUTCOME

With the help of the digital twin, CNHi management and specialists can get detailed and demonstrative information about the economic and production consequences for different maintenance policy configurations. This is done by running various what-if scenarios where the user can vary different core parameters (e.g. maintenance policy, production plan, working schedule, etc.). It is also possible to change the characteristics of the line or a robot, if needed.

The system can handle both the near and far future and, moreover, using the digital twin for simulation provides an easy-to-use tool to analyze and compare scenarios — enabling a quick understanding of how changes could impact maintenance cost. The digital twin provides a wide variety of data, including total production, maintenance time, total cost for spare parts, and the work cost of maintenance. In short, the digital twin is a detailed and comprehensive tool for establishing efficient production line operations.



[Read case study online](#)

[Watch case study presentation video](#)



PWC

MAJOR US AIRLINE
DECIDES NOT TO CHARGE
ADDITIONAL FEES

04

The U.S. commercial airline industry is one of the most diverse, dynamic and perplexing in the world. It is fast-evolving, labor intensive, capital intensive, hyper-competitive and very vulnerable to the ebb and flow of business cycles as well as being among the most regulated of deregulated companies.

Airline management is required to make long-term decisions regarding fleet sizes, market fluctuations, and fuel prices while discovering ways to increase profit in an extremely competitive environment.

PROBLEM

A major U.S. airline was facing a situation where opportunities to extend the existing strategy were limited, coupled with an increasing cost structure due to competition, commodity prices, and acquisition integration activities. The airline began to explore several options to generate new profits through ancillary products or changes to existing policies and was under intense pressure from board members, Wall Street and various analysts to do so.

Although the revenue generation through charging additional fees was apparent in the short term, prior to implementing a policy change, the Airline opted to evaluate the long-term perceived impact on brand equity, market share and customer loyalty.

SOLUTION

PwC, the world's second largest professional services network, was employed by the Airline to model the predicted impact of the client's ticket market share and company brand sentiment after introducing new products or policy changes.

PwC found traditional marketing mix models to be limited and unable to analyze the airline's challenges. First, because they are aggregate,

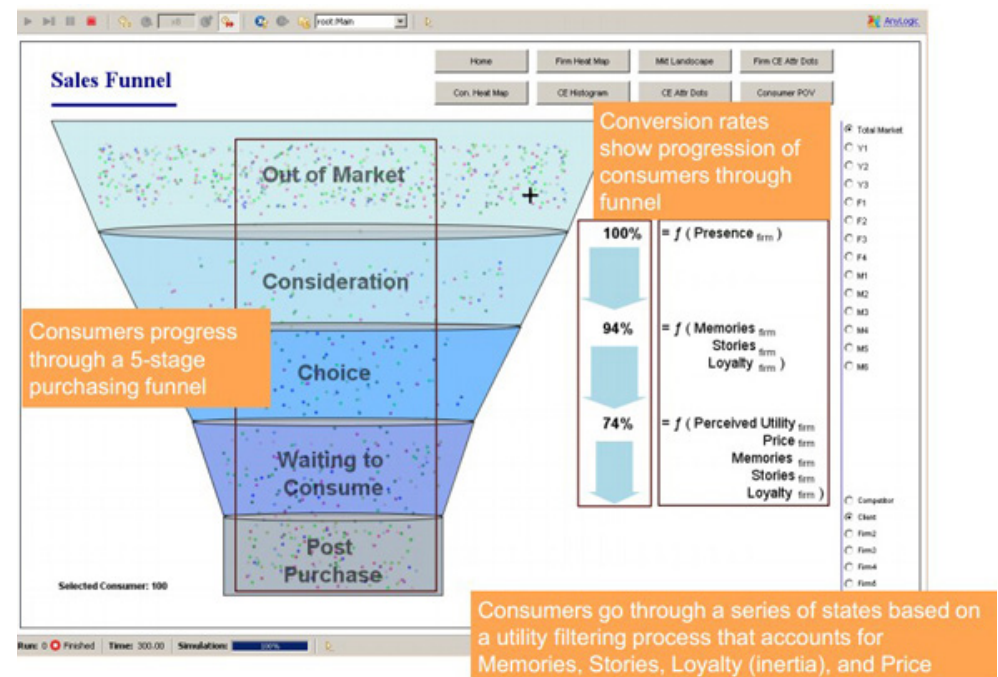

SALES FUNNEL SIMULATION

all customers are represented in a single regression equation which disregards the fact that not all consumers behave the same. Secondly, these types of models do not show interaction between consumers, when in contrary, customers share stories, attitudes, and memories, known as emergent behavior. Emergence is used to describe the behavior a group exhibits because individuals make different choices than what they would if they were not part of a group, as in the market more often behaving as a whole versus a collection of individuals. A third limitation when using typical market models is the lack of explicit representation of the process of consumer decision making. Analysts would be unable to see consumers gathering information, making informed decisions, and forming consideration sets as they do in the real world. Lastly, in traditional regression models, nonlinear relationships are not accounted for, data is limited to time series data, and there is a relatively short time horizon. In the end, this type of model is inappropriate for most consumer behavior analytics.

These restrictions, and an increased likelihood of inaccurate results prompted PwC to explore other modeling options. They chose AnyLogic Multimethod Modeling and Simulation Software due to its flexibility, scalability and capability to handle sophisticated, computationally intensive techniques that model behavior of agents (e.g., consumers) in the market.

Utilizing AnyLogic software, PwC built the Experience Navigator, an agent-based consumer behavior model of multiple airline markets which included client competition, the process of consumers making choices and a relatively complete representation of the ecosystem in each market. The project used historical industry data, behavioral economics principles, and measurable experiences to create a behavioral model to help

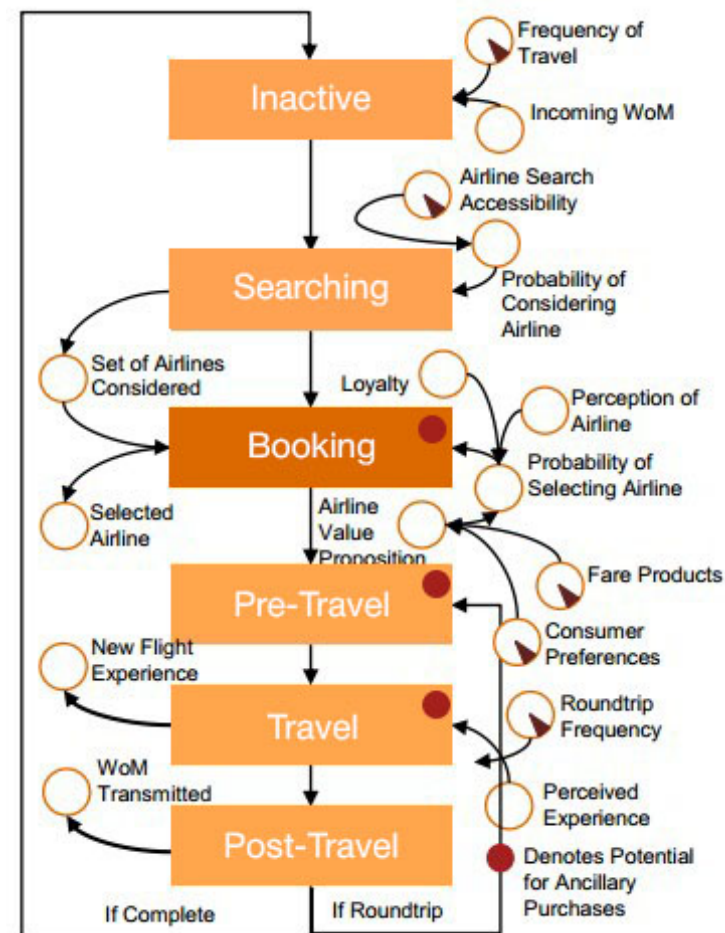



CONSUMER CHOICE BEHAVIOUR REPRESENTATION IN THE MODEL

understand the impact on customers' purchase behavior and the Airline's social contract.

The information used during model building and calibration included:

- **Time series** of airline market shares (i.e. volume, prices)
- **Cross section** of individual travel behavior
- **Market research** from PwC Experience Radar (customer experience survey completed by PwC)
- **Market research** from client discrete choice models
- **Process and theory** from consumer choice literature
- **Qualitative knowledge** of the airline industry

PwC and the Airline are now able to understand how the interaction of different factors (i.e. fare utility, past experience, loyalty and word of mouth) may produce behavior, influence market share and modify markets overall.

-  [Read case study online](#)
-  [Watch case study presentation video](#)

OUTCOME

PwC's Experience Navigator is used to:

- Analyze the Sales funnel at a particular segment and individual competitor level
- Visualize consumers changing beliefs over time
- Dive into different agents to understand their positive and negative experiences
- Forecast revenue impact of change in consumer experience
- Set price and marketing influence levels of the Airline

Ultimately, the model results showed that losses in market share and revenue over the long term would significantly offset any gains from charging additional fees. In addition, the model proved that if the company would set the fees the same as the competition, their loss of market share would be considerably greater than the competition, because the choice behavior for this particular airline was due to positive brand equity and positive perception.

The model provided substantial evidence to convince stakeholders and Wall Street that the Airline should not implement the charging of additional fees but should cultivate an alternate strategy to increase revenue.



CCC

CONSTRUCTION SIMULATION MODEL FOR TACKLING INCREASED CONSTRAINTS

05



OVERVIEW

Consolidated Contractors Company (CCC) is the largest construction company in the Middle East and ranks #18 internationally. CCC has offices and projects in over 40 countries, and a workforce of more than 130,000 employees. Its portfolio includes oil and gas plants, refineries and petrochemical facilities, pipelines, power and desalination plants, light industries, water and sewage treatment plants, airports and seaports, heavy civil works, dams, reservoirs and distribution systems, road networks and skyscrapers.

CCT International (CCT) is the primary technology provider for CCC since 1998. CCT also develops and markets solutions for the construction industry with clients all over the world. CCT products include 3D BIM/project control environments, document and content management solutions, mobile construction management systems, asset management and fleet management systems, QA/QC systems, and construction process simulation and optimization tools. CCT has offices in Beirut, Dubai, Cairo, Athens, and Cyprus with a headcount of around 65+ engineers, software developers, and industry experts.

PROBLEM

Just after contract signature of a site preparation project (earthmoving scope of approximately four million cubic meters), the client and local authorities placed new, more restrictive constraints on the operation. These constraints included:

- Trucks were now allowed to run at a maximum of 10kph within the construction project site instead of the original 20kph.
- Trucks from/to dump location were instructed to follow a specific route full of traffic lights, intersections, roundabouts and security gates. Accordingly, the original assumption of an average of 40kmph truck speed on route from and to dump site could not be maintained.
- Truck sizes/loads were brought down from a maximum allowable of 32m³ to 15m³.
- Number of truck trips restricted to a maximum of 100/hr.
- Only one of the original four site access points was granted after contract signature thus restricting all traffic on site to one gate.
- Only one work shift (10hrs/day) was allowed for dumping at the dump site in contrast to the original two-shift (20hrs/day) schedule.

The newly placed constraints essentially meant that the project schedule will be severely impacted and with it the total cost to complete. The number and complexity of the constraints made it quite difficult to evaluate manually the impact of the constraints on time to complete and equipment requirements. As a result of the newly added complexity the simulation team was asked to help in quantifying the impact of the new constraints and substantiating a claim by CCC for an extension of time.

SOLUTION

CCC already had a well-established construction simulation model made in AnyLogic software. This model was used for basic construction optimization: to forecast equipment and time requirements for earthworks operations. Using the earthworks simulator requires multiple parameter inputs, including the assumed average speed the trucks will travel on their haul routes and back. With a new truck route imposed on the project, it was very difficult to manually estimate the average speed the trucks would run at.

As such, a more complex construction simulation model was built in AnyLogic software to mimic the trucks traversing the route segments, both while loaded and empty. Using optimization techniques in AnyLogic was helpful for risk-free experimentation and for effective construction management on this project.

In the construction simulation model, each route segment was modeled with a stochastic distribution for the total time to traverse the segment. Then the trucks were made to run 10,000 times each way in the simulator to arrive at an average speed for each route and loaded/empty combination.

Why use simulation in construction? AnyLogic was specifically selected for construction modeling because this software allowed CCT to:

- Very quickly build a construction optimization model representing the route and its segments
- Add a map of the routes and superimpose an animation of the trucks traversing the routes to make it easier to explain the work visually to stakeholders.

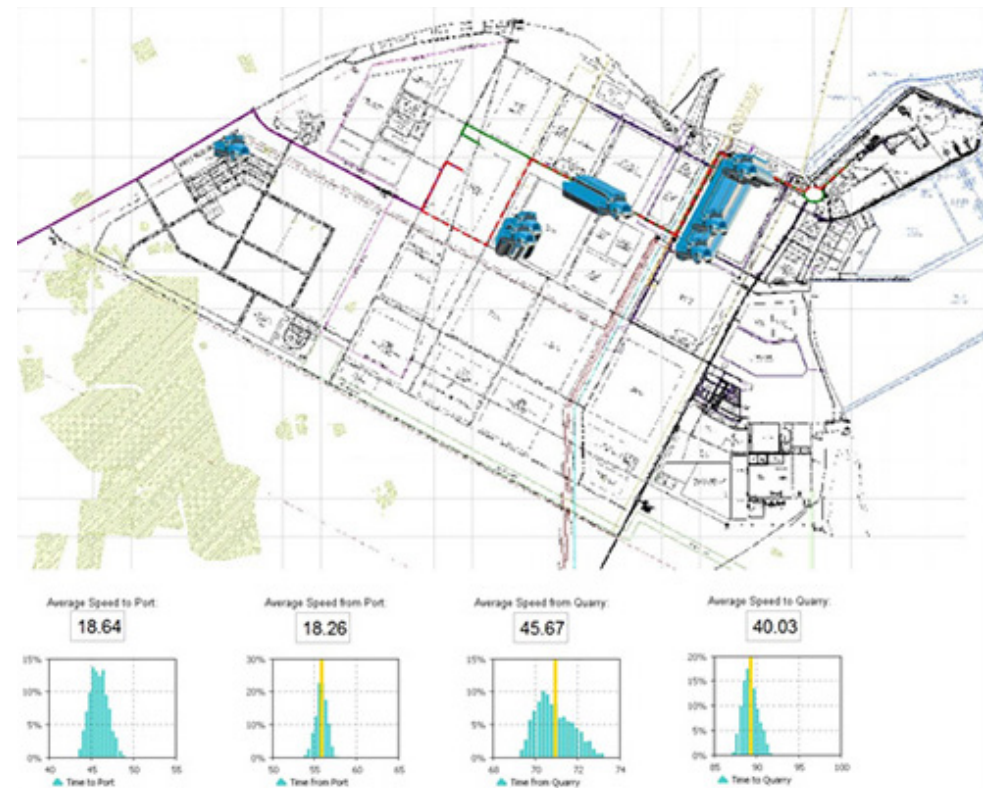

TRUCK ROUTE MODEL OUTPUTS SHOWING ROUTE VISUALIZATION AND AVERAGE SPEEDS

The average speeds deduced from the truck route simulator were then fed into the earthworks construction simulation model along with the remainder of the new constraints. These included:

- Truckload sizes and number of work shifts (working hours) per day to produce multiple scenarios showing the original forecast time and equipment requirements to complete the operations.
- The current forecast time and equipment requirements to complete the operations (impact quantification in time and resource requirements).
- Proposed mitigation scenario.

OUTCOME

The results of the two-step process of using the truck route simulator to summarize the route and then feeding it into the earthworks simulator enabled CCT to quantify very quickly the impact of the new more restrictive constraints and to build mitigation scenarios to aid in the claim for extension of time. Both of the construction simulation models were created in AnyLogic software, giving them the flexibility to consider all the new constraints.

AnyLogic optimization techniques have proven to be good assistants for construction management. Based on the construction simulation model results, the client agreed to extend the total duration of the earthworks operation by an additional 50% on top of the original schedule

duration, and to allow two work shifts per day. This essentially saved the project an estimated additional cost equivalent to 18% of the original total contract value.

 [Read case study online](#)





PASSENGER FLOW SIMULATION

06

As the operating company of several major international airports, Fraport AG is one of the main “Global Players” in the airport industry. With more than 140,000 passengers per day and over 80 aircraft movements per hour, Frankfurt airport – an aviation hub of worldwide significance – is Fraport AG’s busiest airport and its home base.

Between 1980 and 2010, the annual passenger flow through Frankfurt airport has more than tripled from 17 million to 53 million. In its 75-year history, the airport has gone through a variety of construction projects in order to adapt the facilities and meet increasing demands. The result of these adaptations is a very complex structure and the necessity for airport optimization technologies.

FRANKFURT AIRPORT OPTIMIZATION USING ANYLOGIC SIMULATION SOFTWARE

Because further structural changes were limited, Fraport AG decided to develop an airport passenger flow management system in order to improve capacity planning and customer satisfaction, e.g. by optimizing airport processes and reducing waiting periods.

Using active terminal management, the passenger flow within the airport building is controlled, for example, by dynamic signage. The terminal management itself is based on measurements of current passenger flow and forecasts for the future.

Core to the forecast methodology is an airport simulation model that was developed by acp-IT AG on behalf of Fraport AG. This airport

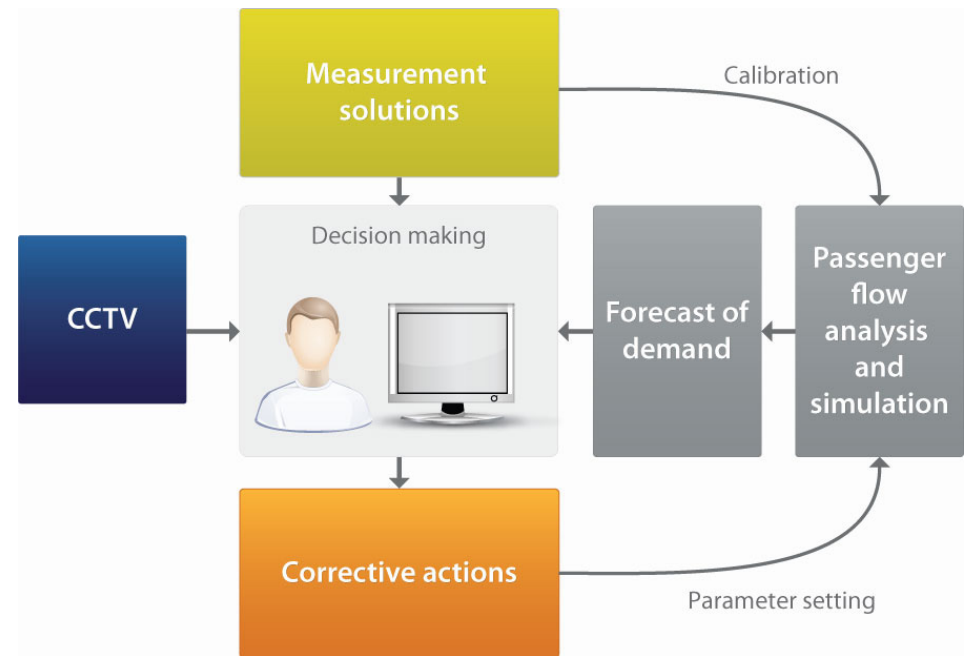

AIRPORT PASSENGER FLOW MANAGEMENT (SOURCE - FRAPORT AG)

model is based on the acp-IT InFrame Synapse Simulation Suite and the simulation software AnyLogic.

In addition to meeting simulation accuracy demands, the target was to achieve very high-performance passenger flow forecasts, looking several hours ahead and calculated within a few minutes. All the essential characteristics that affect passenger flow in the airport had to be considered. This meant that in addition to the 26 security check points, 8 boarding pass check points, 15 border control points, 90 stairways and elevators, 266 gates, 1 tunnel and 3 SkyLine stations, accurately

modeling the passengers themselves. For their representation, a simple mathematical model, a trajectory model, and a, so-called, social force model, which considers the interaction between people, were implemented and compared for accuracy and performance.

The trajectory model, as well as the social force model, provided the required accuracy to forecast airport passenger flow. However, the simulation speed of the trajectory model was about twice as quick. Since it took about five minutes to perform the simulation, the performance targets were met.

Since the summer of this year, the terminal management of the Fraport AG has successfully been using the airport simulation model to optimize passenger flow. The simulation is run almost 300 times per day and about 15 GB of data is generated. With the help of passenger flow management it was possible for 5.5 million passengers to pass through the airport, marking the most successful month in the history of the airport – without any problems.

» [Read case study online](#)

» [Watch video of the airport simulation model](#)

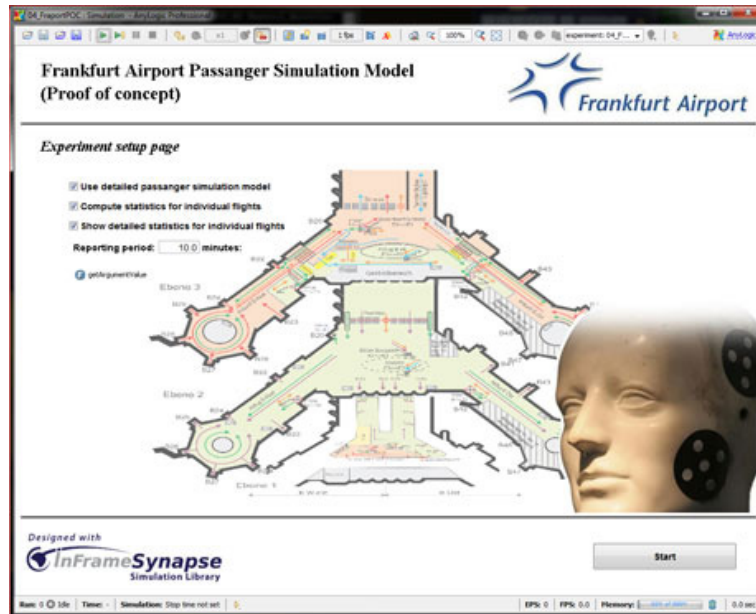

AIRPORT PASSENGER FLOW SIMULATION MODEL START SCREEN
(SOURCE - FRAPORT AG)

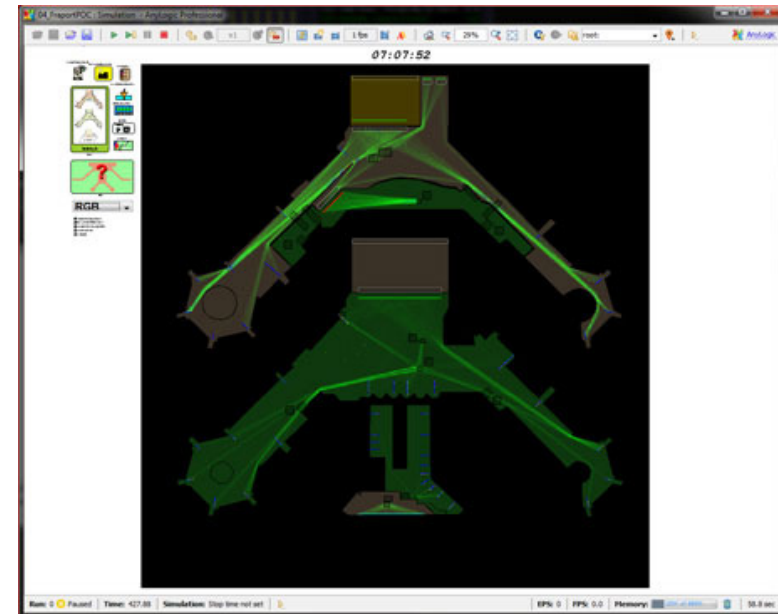

AIRPORT PASSENGER FLOW SIMULATION MODEL REPRESENTATION
(SOURCE - FRAPORT AG)



SOLVING RAILROAD OPERATION CHALLENGES

07

CSX is a railroad company that operates about 21,000 route miles (34,000 km), including one of the three Class I railroads, which serves most of the East Coast of the United States, and reaches nearly two-thirds of the country's population.

The Network Planning division's role is critical to the company's success. This division identifies where to add capacity to accommodate future growth, ensures infrastructure can support and sustain a high level of service, and tries to improve the efficiency of capital spending.

Network Planning uses a multistep approach to manage the network capability. They utilize analytical tools to monitor current service levels, identify appearing problems, and determine the root cause of these disruptions (if the problem is operational or infrastructural).

In addition, they analyze what possible solutions can be applied to the problem, including investment decisions, and which of these decisions will provide the best financial return. To get the right answers, the use of traditional analytical tools is insufficient. That is why, for these purposes, CSX employs simulation modeling technologies. They use AnyLogic software for many different purposes because it allows them to create models of various systems, at the required abstraction level, with a quick turnaround time.

AnyLogic allows the railroad industry users to simulate line-of-road, terminal, and yard problems. The following three projects, completed by CSX in 2014, covered a variety of tasks that were solved using AnyLogic software.



MGA LINE INVESTMENT PLANNING

PROBLEM

A rail line that is jointly owned by CSX and their competitors was expected to see a large growth in demand from several coal mines. The high competition between the two companies meant that if one of them could not fulfill the demand, the other one would do so. CSX needed to identify the best operational/capital strategy to handle the increased business. They wanted to know the answers to these specific questions:

- Did they have enough staging capacity on the line to stage empty unit coal trains to respond quickly to the new demand?
- Where were the best locations on the line to add the additional staging capacity if needed?

They utilized AnyLogic simulation modeling to find the answers.

SOLUTION

The created supply-chain network model simulated the demand of empty trains from five coal mines, as well as the fulfillment of the demand, and staging of empty trains. The trains were modeled as agents moving across the network. By varying values of relevant parameters, users could infer the impacts of different factors to the train throughput (i.e. staging capacity, as well as loading speeds at the coal mines).

The model calculated the company's achieved throughput, and the business lost by CSX, due to the lack of available trains.

OUTCOME

The model provided a way for decision makers to gain insight into the system to help identify the maximum possible throughput. The simulation showed that the company did not have enough staging capacity to serve the increased demand, and it helped distinguish the highest priority capital investment projects to implement.

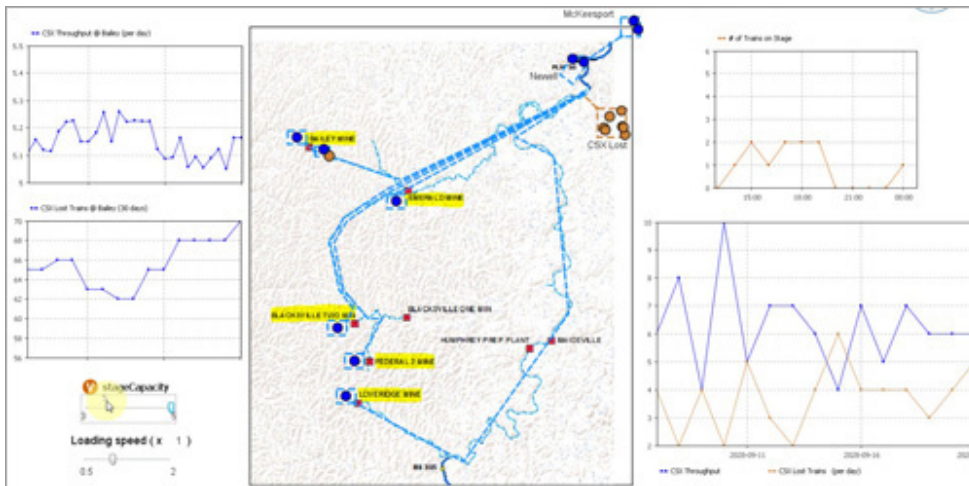

MGA RAIL LINE SIMULATION

NASHVILLE LOCOMOTIVE SHOP REDESIGN

PROBLEM

The CSX's Nashville locomotive shop needed to be expanded in order to meet the higher level railroad network redesign. The facility included a quality maintenance shop and a roundhouse. The company's mechanical department needed to select the best layout design from eight alternatives. The objective was to identify the layout that maximized the throughput of locomotive processing.

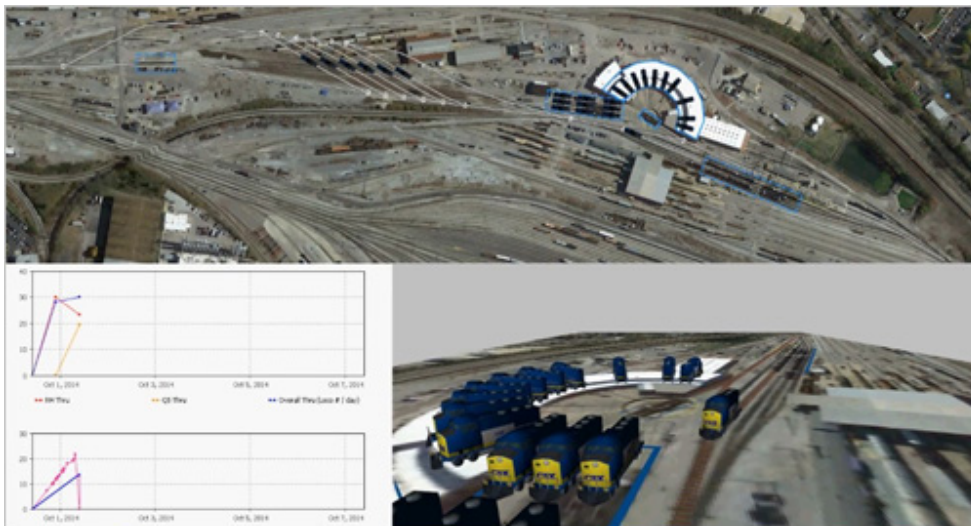

LOCOMOTIVE SHOP SIMULATION MODEL

SOLUTION

This project utilized the special AnyLogic Rail Library to build a model of the locomotive shop and test the different designs.

In the model, 72% of the incoming locomotives went to the roundhouse, while 22% went to the maintenance shop. The remaining 6% could go to either of them, depending on the problem they had after further inspection. Service times in both shops differed.

Locomotives moved at five miles per hour in the system. There was one common queue, with nine spots, for both shops. A locomotive was pulled into the system if there was a spot available in the roundhouse, the maintenance shop, or the common queue. The numbers of spots available in both shops and in the queue were parameters that could be varied by the user.

OUTCOME



The model was used by the mechanical department to test their assumptions by experimenting with the system, and as a decision support tool to determine which layout configuration was best. The model helped the specialists drive the conversation among the stakeholders and base their solution on the reliable data.

NETWORK PERFORMANCE EMULATOR

The company faced greater than expected demand growth, coupled with hard winter weather and resource constraints, which led to congestion on the northern tier of the CSX network. When they analyzed this problematic situation afterwards, the Network Planning team was trying to determine what happened on the network and could avoid these issues in the future.

As the research continued, they found out that it would be easier to understand the processes if they replaced the traditional analytical methods with a visual emulator. So, they decided to reproduce, or replay, the past system behavior in AnyLogic with the use of animation on a GIS map to better understand density, flow, and congestion processes in the network and improve decision making. All of the train movement data was imported to AnyLogic from the databases, predefining the behavior of the trains in the model. The emulator included the animated train movement with statistics and indicators making the data visually understandable.

The model was presented to the C-level officers and the customers and helped drastically raise the understanding of the issue among the stakeholders.

-  [Read case study online](#)
-  [Watch case study presentation video](#)

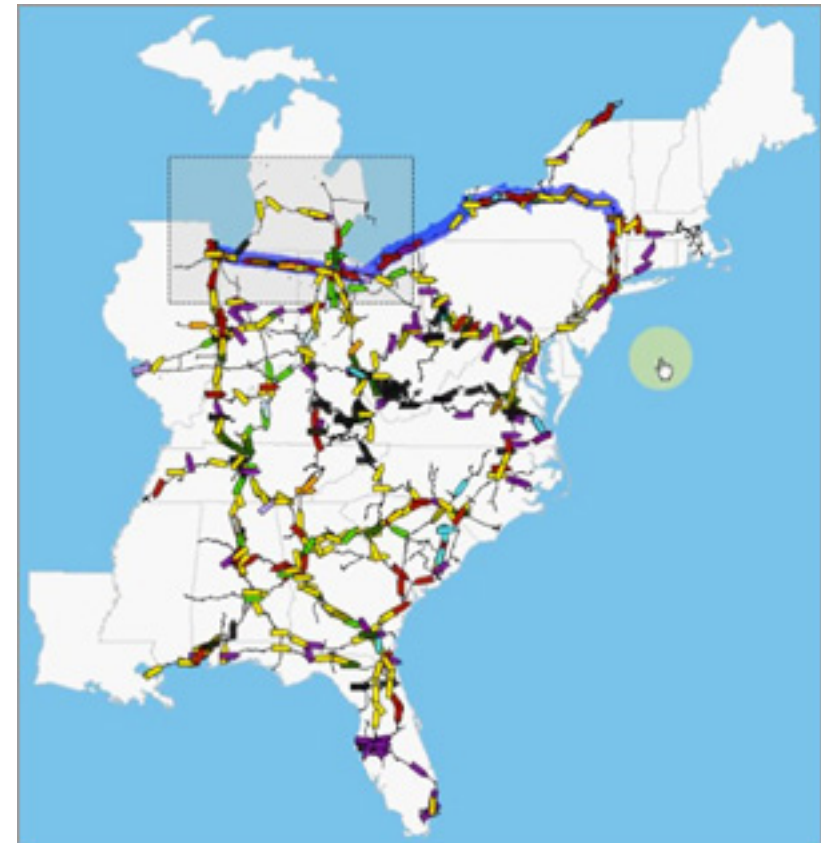

RAIL NETWORK EMULATOR



LOCKHEED MARTIN

IMPROVING PLANE MAINTENANCE PROCESS

08

PROBLEM

We all take commercial air flights from time to time. However, less well known is how complex plane maintenance can be. The military aircraft turnaround process (the time between an aircraft touching down and being ready to fly again) is even more complex and includes multiple interactions and parallel workflows. In addition, skilled staff are needed to maintain a sustainable level of aircraft turnaround, which leads to associated costs.

Engineers from Lockheed Martin, one of the largest companies in the aerospace, defense, security, and technologies industry, used AnyLogic simulation software to improve decision making for the whole military airplane turnaround process and to evaluate the impact of process changes on aircraft turnaround time.

SOLUTION

For a complete model, the three main elements of the turnaround time process had to be considered:

- Aircraft inspections;
- The signoff, meaning all the inspections and refueling have been completed;
- The review and storage of any maintenance codes that were downloaded from the aircraft.

Once these processes were clarified, a mobile application was designed to enable the recording, validation, and understanding of each process at every stage of maintenance. This data collection tool was used by observers who monitored the maintenance staff. The application was modified several times over the course of the project to refine its operation.

For each step in the workflow the actors, resources, dependencies, and other process definition data were identified. The data needed for the model included the start and stop times of each task. In addition, it was important to provide an audio recording capability to capture

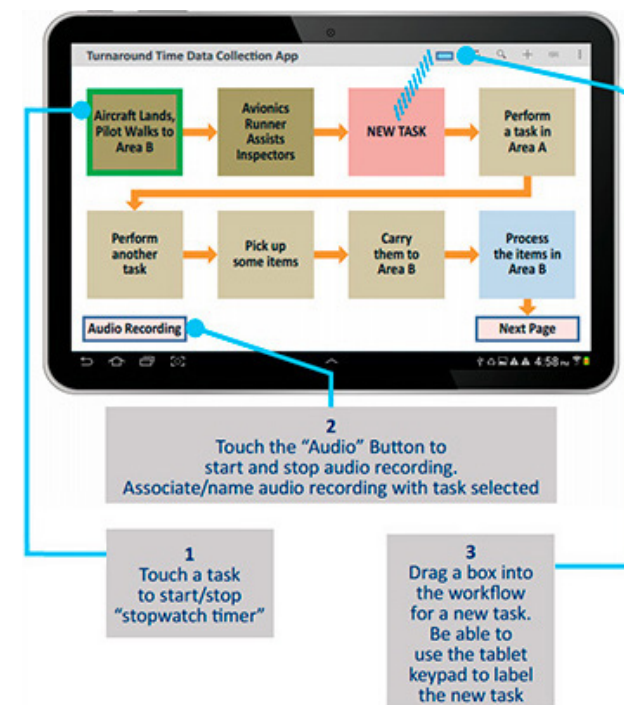

activities that were not otherwise provided for in the application. For example, observers might record the reason that a task was taking longer than expected, or record that they had accidentally pushed the wrong start button. It made the data collection application highly flexible and adaptable.

Studying the aircraft turnaround process revealed that the modeling and simulation environment should include experimentation and presentation capabilities. AnyLogic simulation software fulfilled these requirements and had already successfully fulfilled aerospace projects. Additionally, the process visualization possibilities allowed the model details to be presented to all levels of developers and senior management. These visualization abilities are highly valued in the aerospace and defense industry.

Following the process capture stage, the agents, resources, and tasks were modeled and in a process flow using AnyLogic simulation software, including the creation of multiple visualizations. Baseline models of the current processes were then built. These were iteratively run in a deterministic mode for debugging purposes, and also as single and multi-run Monte Carlo modes. The outcomes were compared to what had been experienced previously on site.

After validating and updating, a stochastic agent-based model was able to capture the dynamic and interacting processes that comprised the turnaround process. To make the process more efficient, experiments were performed to quantify the impact of process changes, whether through the deletion of process steps, a reduction in the amount of time needed to execute a process step, or the redefinition of process sections.

The experiments helped:

- Record the characteristics of the current workflows.
- Explore workflow alternatives.
- Forecast the impact of the alternatives.

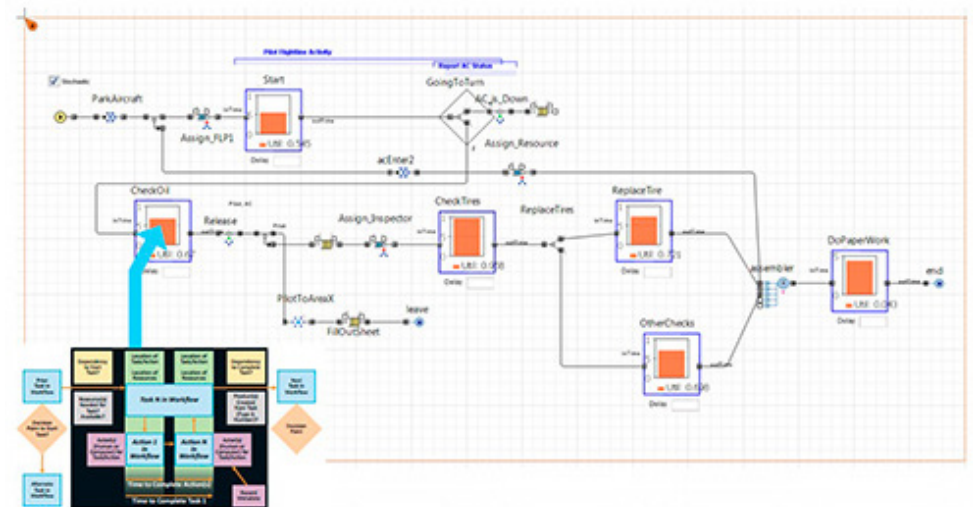

AEROSPACE SIMULATION SOFTWARE

OUTCOME

Various experiments with the model, including with the Monte Carlo method, resulted in suggestions that showed which process modifications would make the most difference. AnyLogic helped model the people/machine/workstation interactions, and also revealed workflow peculiarities that had been unknown before the experiment, including:

- People not following a linear work path. Explaining why actions in the workflow were not synchronized and acting in parallel at times.
- Interdependencies between tasks that were not obvious when looking at individual parts of the process.
- A holistic view of the turnaround process that showed where time was being lost.

This new information and the testing abilities, enabled with simulation, let engineers identify and understand the bottlenecks in the turnaround process. The resulting proposals and modifications to the workflow, brought sizable improvements to the airplane turnaround process, proving the project, and simulation modeling, a success.

 [Read case study online](#)

 [Watch case study presentation video](#)





TRANSOCEAN

SIMULATION BASED
DIGITAL TWIN FOR WELL
CONSTRUCTION PROCESS
OPTIMIZATION

09

About Transocean

Transocean is one of the largest offshore drilling companies that provides rig-based well construction services worldwide. It operates a fleet of versatile, mobile, offshore units comprised of midwater, deep water, ultra-deep water, and harsh environment floaters. The company's dedication to innovation and constant performance improvement led them to search for the best technical solutions.

PROBLEM

Offshore oil and gas well construction is a complex process that takes a considerable amount of time. It demands certain sequences of both manual and semi-automated operations carried out in unison, as safely and efficiently as possible. Different kinds of equipment are usually created and operated independently. However, at the rig, all technical units are integrated. Any kind of delay in machinery increases the critical time path, which reduces the efficiency of the overall performance, and can lead to financial losses.

The critical time path can vary depending on various factors, including:

- Equipment manufacturers and configurations
- Experience and fatigue of operations personnel
- Rig type and drill floor layout
- Weather conditions

- Equipment maintenance
- Wellbore conditions

It is hard to track the dependencies of such variations and resulting inefficiencies throughout the overall process. For this purpose, the engineers needed to focus first on the different states of equipment; decomposing the process to the simplest levels, then combining these states, and finally seeing how they work together in the scope of other factors, including high-safety standards.

To handle possible variations and inefficiencies of the well construction process, Transocean engineers needed to collect and assess measurements at dozens of rigs, including machine and crew timing. A tremendous amount of data had to be collected and then analyzed, and if they managed it manually, it would be too time-consuming. That is why engineers decided to build a well optimization simulation model based on the machine data, including control signals from the equipment. Simulation would help engineers build an oil well optimization digital twin, which would reflect and help analyze the interdependencies among various operations to reduce downtime. Simulation outputs would enable the managerial staff to determine the real reasons of time loss and find solutions.

SOLUTION

When building the oil well optimization model, engineers focused specifically on the tripping stage of the well construction process. It usually takes 20-30% of the overall well construction time, and it is

semi-automated, so there is tremendous variability in the equipment performance. The process consists of operations such as block retracting, block hoisting, and bringing the pipe to the well center, some of which are done simultaneously.

Using AnyLogic oil well construction process simulation software, and leveraging state machine algorithms and discrete event process modeling, Transocean was able to analyze the tripping operations in real time. The whole process was decomposed into a hierarchal system of four main operations that were also split into functional elements down to the

simplest levels. This allowed the engineers to create the state machine model. This well construction optimization model was integrated with a discrete event process model, which altogether represented the system of the entire tripping process with the built-in machine logic of 4-5 devices.

- » [Watch Statistics for oil well simulation and optimization model](#)
- » [Watch Transocean Builds Digital Twin for Well Construction Optimization](#)

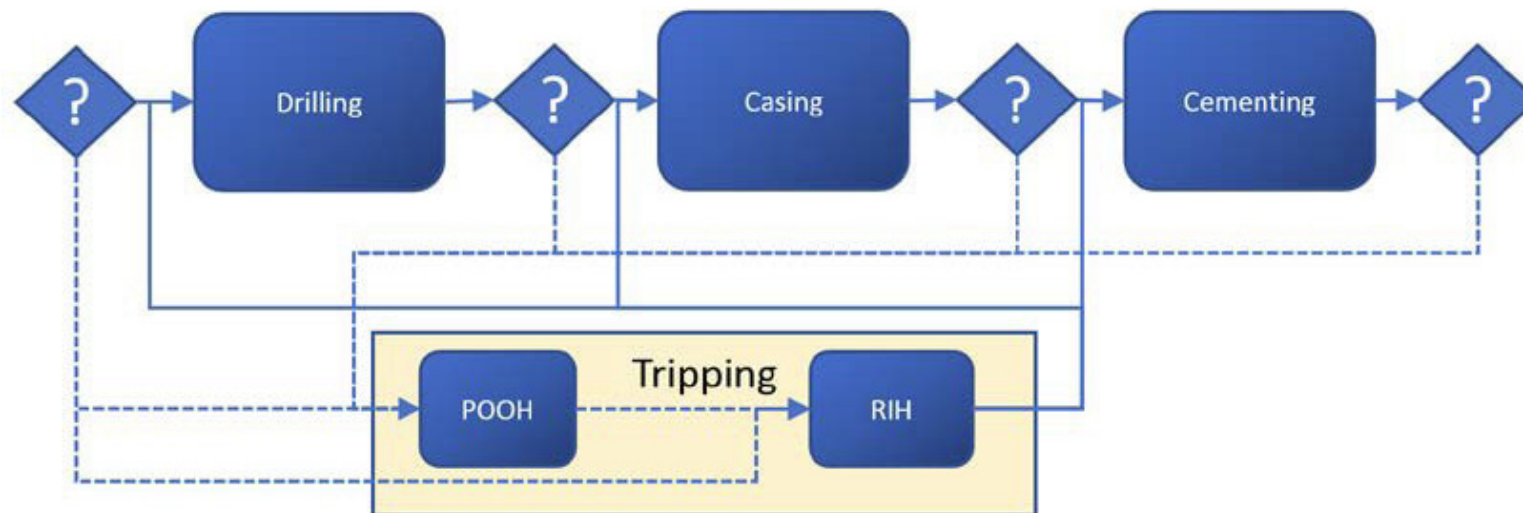

WELL CREATION PROCESS FOR FURTHER OIL WELL

The AnyLogic simulation allowed engineers to put in machine data to both models in real time and receive a range of results that could be presented in dashboards and colored charts to identify machine states and process activities, capture descriptive statistics, and analyze the time critical to operations for its minimization.

The application output the data to an SQL database, and then to BI-tools. This permitted the management and operations teams to have the necessary visual aids, and with the given information, look for the exact reasons of downtime and performance inefficiencies.

OUTCOME

With AnyLogic oil well construction process simulation, Transocean engineers were able to represent the whole tripping stage of the well construction process. With real-time machine data and detailed representation of operations, the oil well optimization model performed as a digital twin, aiding in analyzing well construction activities. Model statistics were fed back to operations personnel and rig managers, allowing them to assess how well crews were performing and identify causes of time loss. The initial results indicated that over 20% of time could be saved by implementing the digital twin.

Future implementation of the oil well construction process simulation for this project might result in assessing a new well profile and predicting the oil well's performance. The profile could be run through the model, essentially drilling a virtual well, and could provide future insights into performance of the well, considering material handling, resources needed, and logistics around the rig.



[Read case study online](#)

[Watch Transocean Model Built with AnyLogic Well Construction Process Simulation Software](#)





GOLDRATT

IMPROVING RELIABILITY AND
PROFITABILITY OF INTEGRATED
STEEL SUPPLY CHAIN

10

PROBLEM

Today, many steel manufacturers are in need of lean manufacturing tools that will improve their return on investment and service levels. The minimum 80% reliability level most steel companies are struggling to achieve is nowhere near what today's customers and investors want to deal with.

One of the largest and oldest European steel manufacturers came across these problems and was desperately trying to solve them. All of their initiatives ended up in endless debottlenecking, rather than building a stable system. The company called upon the assistance of [Goldratt Research Labs](#). Together, they decided to transform and optimize the company's supply chain because it had a high degree of fragility to external changes, low profitability and ROI.

At the time, the company's management couldn't make any effective changes because the supply chain was very complex. It was very difficult and risky to decide on any new rules, as the outcomes were hardly predictable. The static decision support tools like ERP (enterprise resource planning software) or Excel spreadsheets were not able to help because they were never designed to support decision-making within such a complex environment.

To fully consider all the interdependencies, constraints, dynamics, and variability in the system it was decided to employ simulation modeling. With manufacturing process simulation, engineers could capture all the complex details of the manufacturing supply chain, determine causes of performance gaps, and test possible solutions in a safe digital environment. Simulation modeling was supposed to help management



make faster, better decisions and predictions, so that they could turn these predictions into reliable manufacturing optimization commitments to investors and customers.

SOLUTION

Several models were built, so that together, they could represent the whole integrated steel production supply chain. AnyLogic manufacturing

supply chain simulation software provides an opportunity to use different modeling methods in one model. The developers took advantage of this multimethod modeling capability and integrated agent-based, discrete event, and system dynamics approaches in the models. This made it possible to reflect all the components, processes, and interdependencies. All the models had the functionality of showing the outcomes for single scenarios, sensitivity analysis for various parameters, and direct scenario comparison.

The data for the models (more than 70 Excel worksheets) was collected from ERP and EMS. AnyLogic ability to create self-configurable models from external data helped cut development time significantly.

The manufacturing process simulation models has detailed 2D and 3D animation. The AnyLogic platform provides easy-to-use interfaces and the ability to export models as a standalone application, and run the models on any computer without special software. Mobile work and collaboration, being crucial for fast and efficient decision making today, were facilitated by AnyLogic Cloud. This web service enables users to run demanding models online in a web browser on any device, including mobile phones and tablets, share models, discuss scenarios, and provide simulation analytics to customers.

HOT COIL FINISHING SIMULATION MODEL

The hot coil finishing area had a great number of congestions and there was a permanent coil movement in order to dig out the coil needed. Even the car parking was filled up with coils, which indicated the system was

working ineffectively. New decisions to avoid congestion and improve flow were necessary.

The designed model simulated the location of all the coils in the system. For each coil, the type, the destination, and the storage location were specified.

The model helped identify efficient options for congestion reduction based on throughput, in-process inventory, and cost impact. Operational changes, including increasing hot strip mill output and coil width doubling, were tested for better production planning and control. The model also helped find the best way to upgrade and optimize wagon fleet. In the future, the model may be used for testing new operational rules that allow for full automation of the hot coil management process.



[Watch Hot Coil Finishing Simulation Model \(video\)](#)

STEEL AND SLAB SIMULATION MODEL

The steel operations and their scheduling are both very complex. It is very difficult to predict the impact of changes in product mixes or operational rules. To test them and improve efficiency, a specific model was needed.

This model enabled the developers to grasp all the elements of the manufacturing system. Within the detailed 2D animation, a user can click on any crane or product to see its status and on-going operations. The heart of the model is the logic which supports the production planning and

scheduling of all operations. Required product mix and other parameters can be set and altered, and manual scheduling is available if needed.

The steel and slab production simulation model made it possible to:

- Capture and digitize the scheduling and operating rules that different plant operators used. These rules had never been verbalized before and could eventually be lost. Now the personnel can learn from shared experience.
- Develop scheduling and operating rules to avoid bottlenecks. For this, different speed restrictions and alternative prioritization rules for different products were tested and analyzed.
- Forecast the operational and financial impact of producing more complex and higher margin products, which could negatively affect workflows.

 [Watch Steel and Slab Simulation Model \(video\)](#)

STEEL SUPPLY CHAIN MODEL

As mentioned above, the company was experiencing great congestion on the factory floor and low reliability. The company had lots of inventory and couldn't manage it properly. It was necessary to determine the main causes of such situations, identify new global optima rules to be implemented,

and quantify their operational and financial benefits. Goldratt Research was tasked to provide a production optimization and decision support tool which managers could use when developing production planning and scheduling.

The model represents every part of the supply chain in detail. The user can click on a link in the supply chain and see the processes inside. Model statistics presents information on stock levels, processing units, financials, etc.

As a result, it was discovered that problems were primarily caused by the management always choosing the lowest cost-per-ton option for manufacturing and distribution. The other problem was permanent balancing of capacities. The model may be helpful in:

- The development of new "Low WIP/Max Flow" rules.
- Forecasting cost-per-ton, if the company shifted to a more demand-driven approach.
- Making annual commitments, regarding the level of performance, using the full financials the model provided.

 [Watch Steel Supply Chain Model \(video\)](#)

OUTCOME

Using the models, Goldratt Research and its client managed to ascertain the causes of the congestions and low reliability the company was experiencing over the last years.

When the time came, the models provided a safe, low cost, and very quick way to test the impact of any changes on both operational and financial performance. The models were also used to validate each other's results.

In the future, the models can be used on a weekly, monthly, or annual base to analyze workflows and make critical decisions and reliable commitments.

 [Read case study online](#)

 [Watch case study presentation video](#)





LE HAVRE

INTERNAL RAIL LOGISTICS SIMULATION

11

PROBLEM

The Port of Le Havre, the largest container port in France, needed assistance with the construction of a new multimodal terminal. The new terminal would include the area where trains and river barges bring containers for further sea transportation. In this area, cranes move the containers from the carriers and load them onto supporting rail cars that form shuttles, which then carry the containers to sea transports. The movement of these cars was the focus of the simulation model developed by The AnyLogic Company. The simulation model had to compare these two scenarios:

1. Basic (using simple passive cars driven by locomotives)
2. Advanced (using autonomous cars able to move without locomotives)

The objective was to measure the costs in each case, the Quality of Service (how long containers remain in the system), and possible improvements in the network structure of the terminal.

SOLUTION

The AnyLogic Rail Library was used to model the transportation network. Movements of rail cars, cranes, and other elements of the network were simulated in a low level of abstraction. The consultants had to create two separate models because the two scenarios contained very different logic. The models allowed the user to:

- Assign arrival times and required departure times for each container for the multimodal and sea terminals (with separation into rail and river transport).
- Assign train and river ship arrival and departure timetables at the multimodal terminal.
- Change the characteristics of different equipment (speed of completing different operations) for the multimodal and sea terminals.

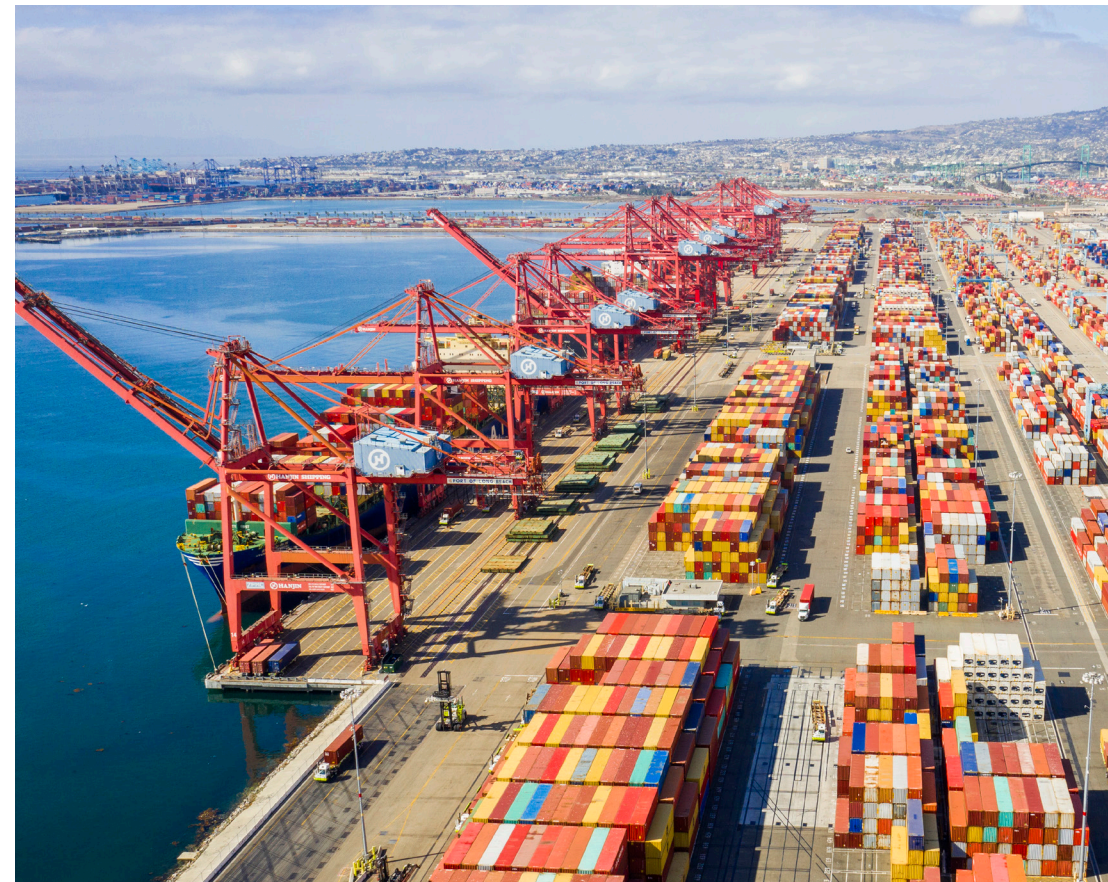

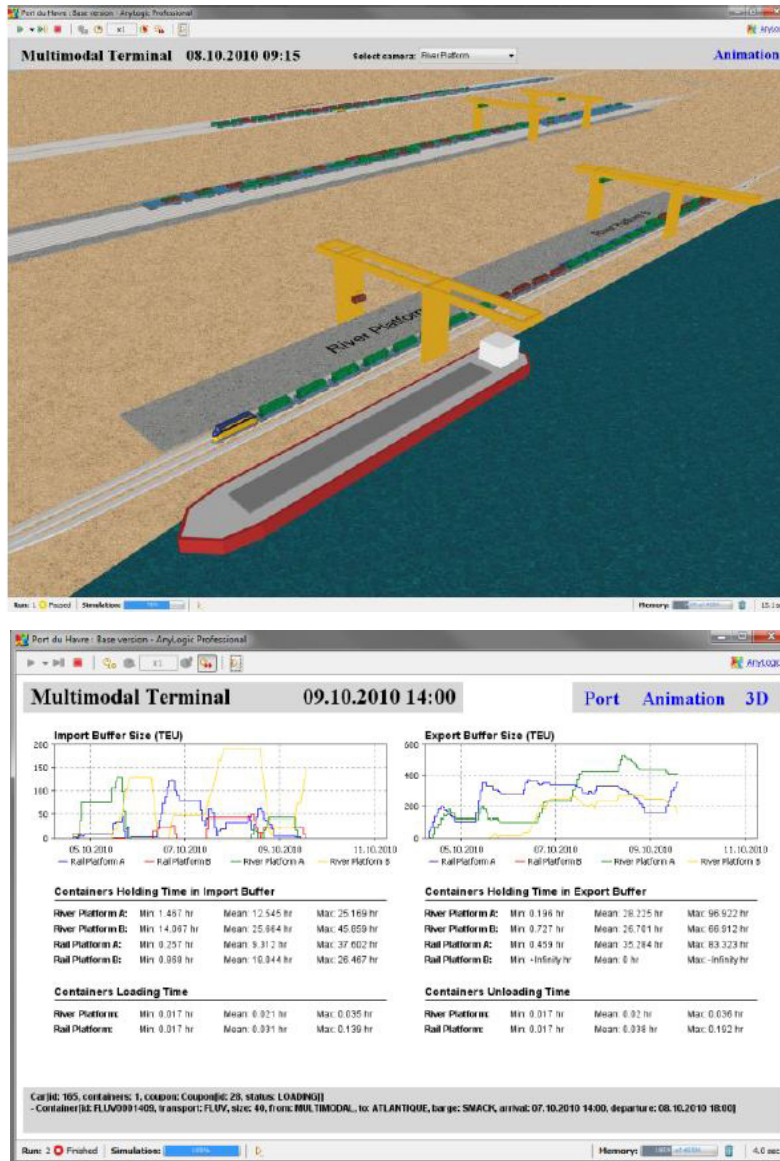

MULTIMODAL TERMINAL SIMULATION

- Dynamically register the space availability for containers at the terminals.
- Dynamically register the costs for different elements of the network together and separately.
- Monitor the status of each entity and agent in the network.

OUTCOME

The results included statistics collected for both scenarios. Costs were calculated for different elements of the network, such as locomotives, rail cars, cranes, and dockers. The data on Quality of Service showed that autonomous cars were more efficient and cheaper than passive ones.

By using the simulation models, the customer could compare the two methods of organization of internal rail logistics, chose the optimal one, and estimate the needed amount of rail cars.

The data obtained from the AnyLogic models allowed the customer to prove the feasibility of the terminal construction project to the potential investors.

 [Read case study online](#)



CARDINAL HEALTH

OPTIMIZING WAREHOUSE OPERATIONS

12

Cardinal Health, a billion dollar pharmaceutical distribution and logistics firm, manages multiple products from brand name pharmaceuticals and generic drugs to over the counter drugs, health & beauty items and their own private label. They face a multitude of typical distribution warehouse challenges that are further complicated by the nature of pharmaceutical products, which are smaller in size, consumable, expensive, and could be life critical. Brian Heath, Director of Advanced Analytics at Cardinal Health, and an experienced user of AnyLogic software, employed agent based modeling to solve various business problems, saving Cardinal Health over \$3 Million annually.

PROBLEM

Cardinal Health is an essential link in the healthcare supply chain, offering next day delivery to over 30,000 locations including hospitals, retail pharmacies, physicians' offices, and direct to consumer. Other value added services including efficiency and demand management, working capital management and contract credit management add to the difficulties of poor manufacturing reliability and supply disruptions in the market due to FDA and DDA regulations. In summary, Cardinal Health must keep up with the variability in pharmaceutical distribution management.

Cardinal Health considers facility layout, flow of product, order picking, labor planning & scheduling, customer order requirements and congestion for analysis and day to day operations management. Traditional analysis tools such as empirical trial and error, are risky, expensive and difficult to make changes. Industrial engineering operations researchers would suggest mathematical models, inexpensive, but the models do not capture

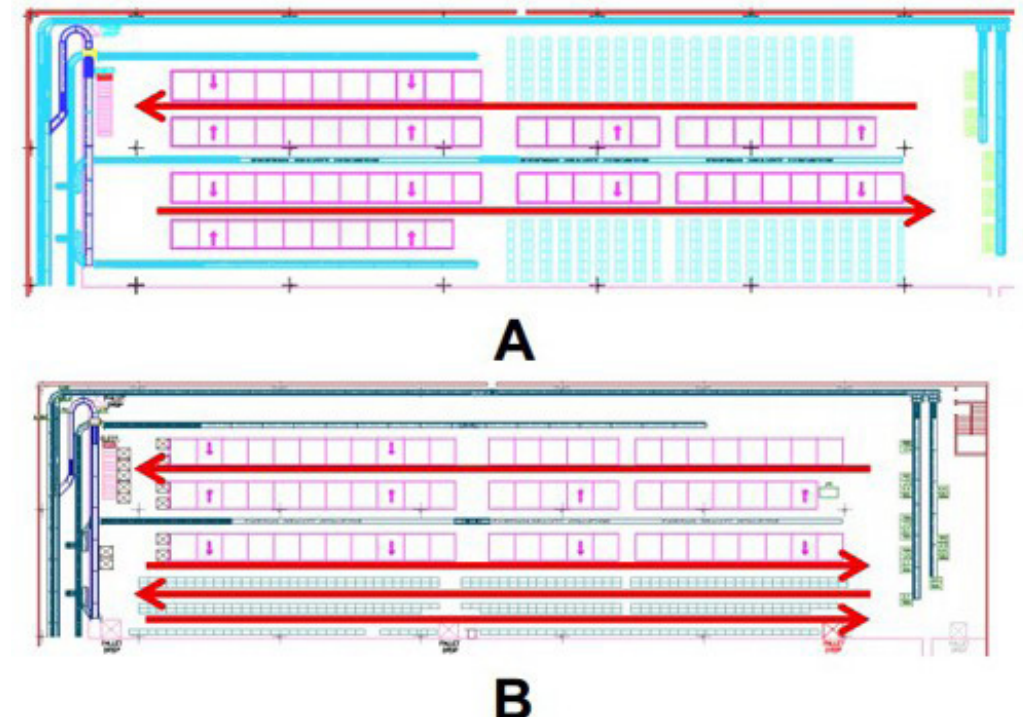

TESTED WAREHOUSE LAYOUT CONFIGURATIONS

unexpected dynamics. If anything is open or has emergent behaviors such as congestion, a standard mathematical model would not be able to solve. Thirdly, process driven or discrete event modeling is not advantageous due to its inability to represent a facility naturally. This led Brian Heath and Cardinal Health to explore alternative analysis options.

SOLUTION

Agent Based Modeling (ABM) with AnyLogic Simulation and Modeling software gave Cardinal Health the device required to tackle many distribution warehouse issues without the restrictions of traditional tools. ABM represents abstractions of distributed autonomous entities that can interact with each other and their environment through space and time, allowing Cardinal Health to capture work time allocation, congestion wait time, cycle times, distance traveled, worker variability and other important metrics.

The model built was ultimately concerned with the activities of employees and the interaction with each other during the day, making it necessary to import data such as picking time and performance standards into the model. Now, Cardinal Health can gather congestion wait time data and see how much of a problem it is causing in the warehouse since “agents” are modeled as individuals with special relationships to each other. Additional parameters included in the model are several worker speeds, worker behavior, learning curves, cycle times, product turn-around and distance covered walking or driving.

The ability to import Excel files was also imperative as Cardinal Health has numerous warehouses, and it is mandatory to test multiple layouts. Using AnyLogic, if a change is needed, it’s as simple as updating the Excel file, importing it into the model and running the model again.

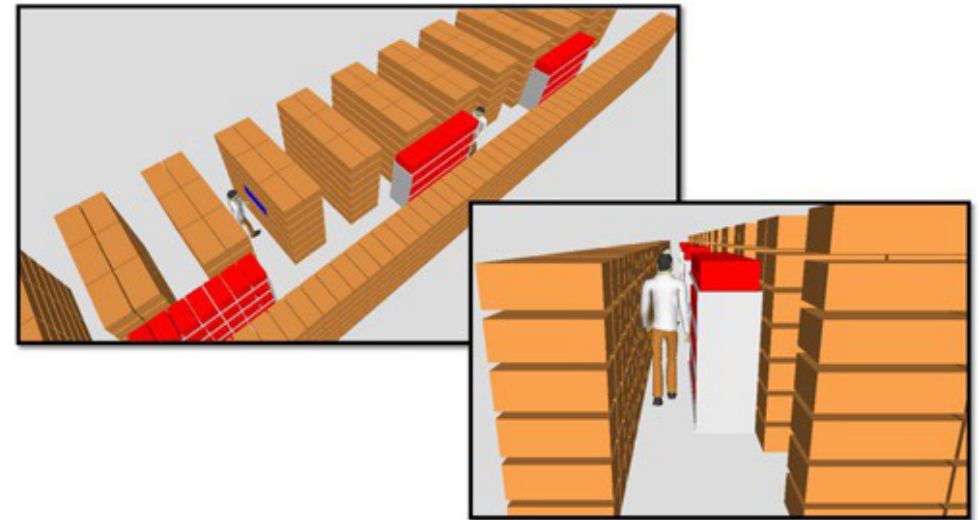

3D ANIMATION



OUTCOME

The Agent Based Model built with AnyLogic software allows Cardinal Health to compare layouts, picking technology and product slotting strategies. In addition, they can evaluate different methods of picking to update staffing models and for on-the-floor support if a workload changes as orders vary on a day to day basis. Statistics is also gathered such as tact time, how many batches are completed in an hour, truck unloading time, and sequencing of events.

Besides the clarity given through the above metrics, the model revealed a problem due to the random distribution of work. Each employee's work load was uneven making one faster and one slower. By balancing the workload, employees began working at a similar pace and congestion decreased dramatically.

By minimizing congestion using AnyLogic software, Cardinal Health was able to decrease the average shift length from 10.5 hours to 7.25 hours

and increase the amount employee capacity. Cardinal Health saves over \$3 Million annually using Agent Based Modeling with AnyLogic Simulation technology.

[Read case study online](#)

[Watch case study presentation video](#)

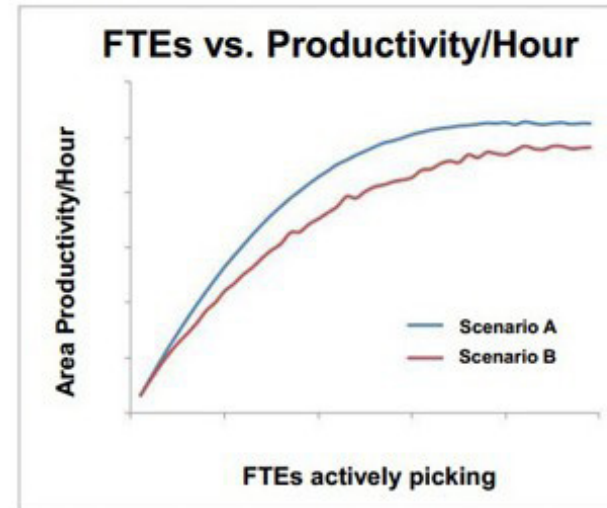

Discovered how to minimize congestion



Discovered Area Capacity by Scenario

SOME OF THE PROJECT'S RESULTS



YPF

RESOURCE OPTIMIZATION IN THE OIL & GAS INDUSTRY

13

OVERVIEW

YPF is the largest oil and gas company in Argentina, with a 43% market share in oil and gas production, and 58% in gasoline. As the third largest company in South America, YPF employs 72,000 people directly and indirectly, and holds 92 production blocks and 48 exploration blocks in basins around the country.

PROBLEM

YPF was aiming to reduce its costs associated with oil wells' maintenance downtime and equipment breakdown. The analysis showed that the root cause of inefficiencies was the lack of a robust maintenance scheduling process.

The main problem was that the scheduling process was decentralized, with planners independently allocating hundreds of work orders each month. Multiple planners were assigning tasks for multiple teams without proper coordination between each other. This prevented them from creating optimal schedules, resulting in downtime losses and inefficient resource utilization.

YPF approached Simcastia, the simulation and optimization business unit within Continente Siete (an Argentinian business data science company), to develop a tool for scheduling, resource optimization and project management at all YPF facilities.

The pilot project was carried out for Rincón de los Sauces, an oil field located in Neuquén, Argentina, with 700 wells (including water

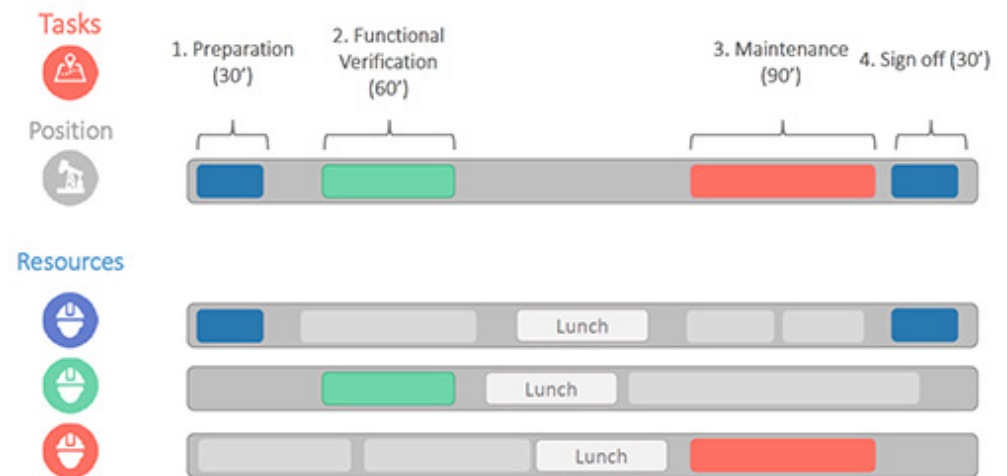

PROJECT MANAGEMENT: DISTRIBUTION OF TASKS

injection and oil wells), about 100 working crews, and more than 100 weekly maintenance orders.

SOLUTION

To manage an oil field maintenance system that included many interacting parts, custom policies, constraints, and time-dependent events, using spreadsheets and analytical optimizers was not sufficient. Simcastia consultants developed a simulation-based optimization solution to manage this complexity. They chose AnyLogic simulation software for its unique flexibility, which allowed them to model specific resource behaviors and custom process rules.



SYSTEM INTERFACE - RESOURCE AVAILABILITY SCREEN

The simulation model included sites with GIS-referenced locations, preventive and corrective work orders consisting of multiple tasks, and resources (staff and equipment) with skills and working hours. All of these elements were modeled as agents with unique properties and behavior patterns.

The costs calculated in the model included:

- **Wells' production loss costs**, including unplanned and scheduled interruptions in operations.
- **Resource-related costs** (both regular and extra work hours).
- **Travel-related costs.**



SYSTEM INTERFACE - RESOURCE AVAILABILITY SCREEN

The solution developed by Simcastia was based on an AnyLogic maintenance process simulation model and custom optimization algorithms. The simulation-based resource optimization used algorithms to allocate resources to work orders and complete these work orders the fastest possible way.

The interface of the software solution allowed the planners to adjust model parameters, such as associated costs, weather conditions impeding some processes, resource availability timetables, and prioritization rules. By changing model parameters, the planners could feed the model data relevant to the changing environment.

Combining simulation with optimization, the tool produced operational plans for 9, 12, and 30 days. It also provided various statistics displayed in dashboards, including operational plan details, schedules by and site, costs and tasks by type, resource utilization rates, extra hours worked, and distances covered.

The resulting solution was integrated with the client's databases and SAP, becoming the part of the company's planning software infrastructure.

RESULTS

This project provided the Rincón de los Sauces oil field with a project management and decision-support tool for maintenance scheduling, which helped improve the site's operational efficiency and resulted in:

- Work order execution increased by 11%.
- Preventive maintenance fulfillment increased to 95% in six months.
- Corrective maintenance backlog reduction of 56%.
- Unplanned downtime oil production losses reduction of 50%.

The direct economic impact of the project included annual yearly savings of \$18M at Rincón de los Sauces. As a second stage, implementation for Mendoza assets (much bigger and more complex) have already started, and the roadmap aims for nationwide implementation by the end of 2018, with expected savings of \$234M per year.



[Read case study online](#)

[Watch case study presentation video](#)



REME

MILITARY AIRCRAFT
MAINTENANCE SCHEDULING
AND STAFFING OPTIMIZATION

14



PROBLEM

The Corps of Royal Electrical and Mechanical Engineers (REME) maintains all electrical equipment within the British Army. REME engineers are tasked with the maintenance, recovery, repair, and manufacturing of the battle equipment to keep it in fighting order at the battlefields and at the military bases, both at home and overseas.

Among other duties, engineers maintain the Apache Attack Helicopter, one of the world's most advanced multi-role combat helicopters. This aircraft is very maintenance demanding: it takes about 35 hours of maintenance to cover one hour of flying. That was one of the reasons REME management considered their unit understaffed and claimed that it had to expand the mechanics department. However, their supervisors from Air Army Corps felt like the REME was being over-resourced, since on average they had enough staff to manage this workload.

Lack of agreement between these two military organizations made it clear that to solve REME's workforce planning problem, the management needed to look deeper into data to make more evidence-based decisions. They tasked dseConsulting company with the challenge to create a robust tool for improving staffing strategies that would help them optimize scheduling and manning, and then increase the availability of helicopters. For these reasons, the consultants applied AnyLogic maintenance simulation and optimization software. The consultants aimed at:

- Representing deployment cycle processes in the digital environment.

- Analyzing cause-effect relationships between the processes.
- Determining robust manning strategies, including the targeted use of planned contractors based on sound evidence.
- Forecasting peak and drop cycles in the workload.
- Learning how human actions, one of the key components of the deployment cycle process, might impact the system.



SOLUTION

The consultants built a simulation model for analysis and further optimization of the maintenance processes during the deployment cycle. The model included three areas of complex behavior lying within the real-life system:

- **Aircrafts** — in the model, they were deployed to different sites, where they were maintained by accompanied engineers, and then returned to the base where maintenance was required. Aircraft components could, in turn, randomly deteriorate during their life cycle.
- **Deployment** — aircraft deployment in the model was simulated for a five-year period. As it was impossible to plan the deployment for such a long term, this uncertainty was reflected in the model. In addition, consultants simulated the wearing out of aircraft components because of environmental conditions.
- **People** — based on the real data, consultants displayed how aircraft maintenance staff experience, individual efficiency, and stress influence deployment cycle processes.

With the AnyLogic multimethod simulation approach, consultants were able to model deployment cycle processes and handle their complexity without any simplification. Among other approaches, agent-based simulation allowed the modelers to reflect the behavior of aircraft engineers in detail, including their experience and the level of burn-out, to demonstrate more robust statistics.



In the simulation model, the following statistics were collected:

- The number of contractors at a given time of simulation and the number of aircrafts
- Utilization rate of staff over time
- Average level of stress
- Average level of experience
- Average staff efficiency

By analyzing the maintenance optimization model results, the consultants concluded that the human factor aspect played an important role in deployment cycle activities. For example, if an engineer was tired and inefficient, the job would take longer and affect all related processes. However, if new staff was recruited, the efficiency level would also drop because new recruits tend to be less experienced. As a result, the REME management had to find the balance between pushing more work to the experienced personnel, causing burn-outs, and hiring less experienced contractors.

The simulation model provided some significant insights for the management:

- When helicopters are at the deployment, the on-base staff utilization is low even though some helicopters are still at base. However, when helicopters are back, they are being maintained with a burst of employee engagement. This fact should be considered in further scheduling.
- When engineers leave for the deployment, few people stay at the base. That is why a risk emerges: if too many helicopters come back at the same time, there will not be enough personnel to service the helicopters. In addition, on-base aircraft engineers might experience heavy overload, which can negatively affect overall job results.
- As planned and emergency contractors are costly to recruit, the model allowed the management to analyze how the number of contractors could be optimized while facilitating workflows.

RESULT

As a result of the maintenance optimization modeling project, the consultants offered the customer a decision support tool that could be used for planning staffing policies and improving staff coordination and management.

At this stage of the project, simulation indicates that with smarter planning there is the potential for a 20% aircraft fleet availability improvement at a lower cost, in addition to the organization's prime targets.

It is estimated that the second phase of the project might save REME about \$2.7 million in staff costs.



[Read case study online](#)



USING PREDICTIVE
MODELING IN HEALTHCARE
FOR SIMULATION OF
CLINICAL TRIALS

15



PROBLEM

Peripheral neuropathy is a condition caused by chronically high blood sugar and diabetes. It leads to weakness, numbness, and pain in hands, feet, and other body parts. About 60% of all people with diabetes eventually develop this disease. To make sustainable treatment decisions and provide personalized healthcare strategies, scientists, doctors, and insurance companies use predictive modeling tools for in silico clinical trials. With these predictive modeling tools, they can forecast how a certain patient might respond to a drug and use this information to make personalized prescriptions.

Pfizer, one of the world's largest pharmaceutical companies, asked Fair Dynamics, in collaboration with Health Services Consulting Corporation, to develop a platform that would help the company's researchers test a new drug for patients with painful diabetic peripheral neuropathy. The platform would be based on previous clinical studies and act as a decision support tool, which could assess a patient's personal parameters, prescribe drug dosage, and predict possible outcomes. The platform also needed to be flexible and have a user-friendly interface to allow inexperienced users to work with it. To develop this platform for predictive modeling and analytics in healthcare, engineers made use of AnyLogic simulation software.

SOLUTION

To create a predictive analytics platform, engineers needed to process raw data from different sources and categorize it. For this purpose, they integrated SAS data files and machine learning algorithm in an AnyLogic model. The algorithm grouped the data with patient profiles



into six clusters with clustering variables, such as gender, age, disease duration, and others. These parameters were essential when completing patient treatment programs.

To include patients in the predictive model, engineers used an AnyLogic agent-based modeling approach, which is commonly used for simulation in healthcare. It allowed users to set up patients with predefined parameters similar to those in the clusters. The patients would then fall into one of the identified clusters depending on these parameters.

Following categorization, the treatment process of each patient was simulated in the model with several treatment scenarios. It was based on the data from the previously clustered patient profiles. To validate the model, the 4-6 weeks treatment for each patient was simulated.

Doctors were finally presented with the optimal treatment scenario and dosage for a patient. For each patient or cluster, users could export dynamically created reports.

AnyLogic capabilities for parallel computation also offered simulation of scenarios with multiple patients using the parameter variation experiment.

As the model was supposed to be used by inexperienced people, engineers used Java technologies, supported by AnyLogic, to complete the convenient interface.

OUTCOME

In this project, AnyLogic acted as a software tool for integrating various datasets, machine learning algorithm, and simulation capabilities. Altogether, they allowed the processing of diverse historical data and its regrouping into unique clusters. With predictive modeling using AnyLogic agent-based simulation, engineers managed to complete an easily configurable predictive healthcare model and simulate personalized treatment processes with great precision. The model helped doctors make informed decisions on drug dosage for every patient and see how he or she would respond to the treatment. With Java-based design elements, the model's interface became more intuitive and could be easily understood by new users.



[Read case study online](#)

[Watch pharmaceutical simulation model](#)

[Watch case study presentation video](#)



SIMULATION OF MATERNITY
WARD OPERATIONS

16

PROBLEM

This model simulates the maternity ward in a hospital currently under construction. Since the new hospital building will replace an existing ward and since the new maternity ward will be staffed by current personnel, the model also simulates current facilities.

The purpose of the model is to support discussions related to which resources, capacity, and work methods are required on the new ward. One relevant discussion is whether to apply an “integrated philosophy” - where the mother and child stay in the same room during their entire stay - or whether dedicated rooms for antenatal care, delivery and postnatal care are preferred, as used in the current system.

The project was carried out for Karolinska University Hospital in the Stockholm County, Sweden.

SOLUTION

Since this problem is on a micro and operative level of abstraction, Discrete Event Modeling is naturally the preferred modeling choice. This enables the handling of resources, processes, patients, etc. in the best way. Further, since this issue requires the comparison of a two distinctive alternatives, it is advantageous to run these scenarios/alternatives in parallel, instead of in sequence. In this way it is possible to pinpoint differences in performance given the same demand. From a modeling perspective, the mother-to-be is “cloned” and sent (and her clone) simultaneously to the two different process alternatives. This method was also chosen especially in this case to support the discussions during two workshops.

This process model focuses on the physical resources. A number of variable parameters enabled the users to experiment with relevant scenarios.

The parameters include yearly demand, number of rooms of different categories for the existing ward and future ward, relevant patient categories and their traits (such as minimum, maximum, and average time for delivery, postnatal care, etc.), proportions/probabilities for forms of care, and prioritization (when several resource types can be used for the same care process).

The process description excludes human resources. To do so the staff schedules, personnel categories, skill levels, planning strategy, etc. should be included. Given that the purpose of the model was to focus on physical resources and investments and support the discussion process, this was unnecessary. The model therefore assumes that there are always enough personnel. The caregivers are animated but are never limiting.



MODEL OF THE CURRENT WARD



MODEL OF THE PROJECTED WARD

OUTCOME

The primary purpose of this model was to stimulate and support the discussions and conclusions in a workshop format. The simulation “provoked” participants into better insights into their situation. From a clearly skeptical outset, the model enabled participants to see that the future scenario was in fact realizable and envisage how they could start to prepare for this.

The outcome can also be seen in the light of that fundamentals from operations management and healthcare management engineering are much easier to understand for those lacking a strong background in these

fields if communicated and presented with the help of a visual simulation model. Examples of such fundamentals include:

- Dividing a total need over several dedicated resources will always cost something in terms of effective capacity compared to having the same number of resources but fully flexible.
- A need evaluation must always be made per resource type – and the amount of resources per type should roughly have the same relationship as the relative needs.
- Historical output, result and production figures can seldom be used to take decisions for systems in the future (with different traits and circumstances).

The output and results from the simulations were summarized in a result window. Indicators were presented for the existing ward and the future ward both numerically and graphically. This enabled the evaluation of the strengths and weaknesses of each simulated scenario.



[Read case study online](#)

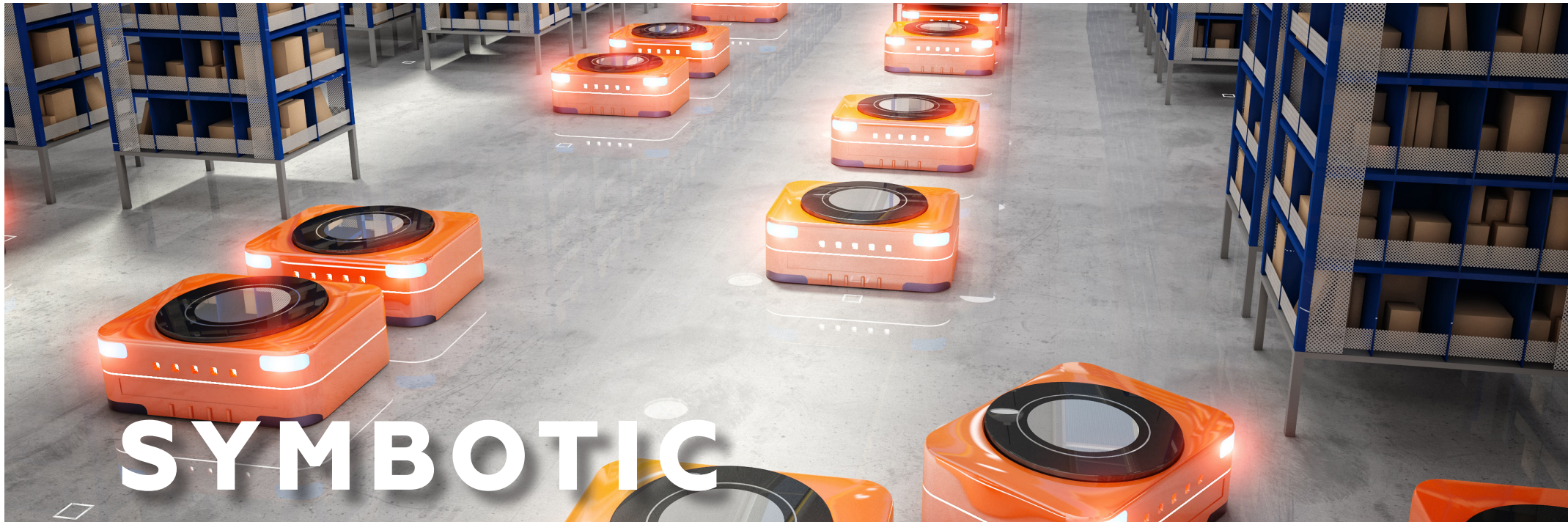

SYMBOTIC

EVALUATING INTRODUCTION OF WAREHOUSE AUTOMATION SYSTEMS

17

CHALLENGE

Symbotic is a warehouse automation solutions provider. Its systems are based on mobile robots that can travel freely throughout a dense storage structure, accessing products in all locations and handling them at a very high throughput rate. The main advantages of the Symbotic System are its ability to operate in three dimensions, and their sequencing and palletizing algorithms that build stable, store-friendly pallets at maximum throughput.

The company needed a tool to help their customers learn the impact of warehouse reorganization and compare capital investments against expected operational savings before the actual introduction of automation systems. This tool had to be easily adjusted to the case of each specific client.

Symbotic specialists decided to use AnyLogic simulation software for this purpose because it could precisely estimate costs and visualize processes inside warehouses in 3D, as well as create models that could be easily reconfigured for multiple projects.

SOLUTION

The models that Symbotic engineers created for the company's clients simulated the environment and operations in their warehouses with a high level of detail. More specifically, this included:

- Scheduling and assignment of dock doors, product flow between the dock doors and several different warehouse locations on both inbound and outbound.
- Tracking and combining order-specific product flows from different streams on the outbound.
- Operations of labor and resources like loaders, unloaders, forklift trucks, de-palletizing and palletizing cells, all simulated as agents.

Each agent type had its own properties, like speed, reliability, operation times for equipment, dimensions, cases per layer, and layers per pallet for each SKU. The input data was taken from real life information.



WAREHOUSE MODEL 3D ANIMATION

It was especially important for the modelers to simulate various interactions between the automation system and human operators. This included receiving incoming deliveries, replenishing stock, both automated and non-automated parts of the warehouse fulfilling customer orders in an optimized sequence, and combining them at the dock-doors in the exact manner it would happen in the projected system. Models also took into account system reaction in case of equipment breakdowns, shift schedules and lunch-breaks for the human operators. The models featured warehouse 3D animation and graphical display of key metrics to provide strong presentation instruments for salespeople and allow the clients to see their future reorganized warehouses in action.

RESULTS

The models were tested on the historic order data from each client, usually for a six month period. To compare warehouse operations, with and without the automation solutions introduced, Symbotic engineers gathered the following statistics in the model:

- Throughput capacity (cases per hour handled)
- Number of human operators required and associated costs
- Number of warehouse resources required (e.g. dock doors) and their utilization
- Time needed to fulfill daily outbound shipment orders, especially during the peak periods

- These outputs were used by the clients to evaluate warehouse design alternatives and justify capital investments.

AnyLogic allowed Symbotic to design their simulation models in a way that made it possible to easily change warehouse layout, operating procedures, SKU properties, etc., so that model elements could be reused in multiple projects with relatively small effort. Also, 3D animation allowed the company to utilize these simulations as a powerful selling tool.



[Read case study online](#)

[Watch case study presentation video](#)





FRUIT OF THE LOOM

CHOOSING LOCATION FOR
NEW DISTRIBUTION CENTER

18



PROBLEM

Fruit of the Loom (FOTL) is one of the largest US apparel manufacturers and marketers. The company was expanding, and the executives wanted to know if it would be beneficial, in terms of shipping costs, to add a new distribution center (DC) in the US, or to redistribute products to a pre-existing DC. The contractors decided to simulate the whole supply chain in order to visualize DC locations on a GIS map, and the supply networks between them. Focusing on wholesalers, the company considered distributors as customers. No small packages or end-users were involved in this case.

SOLUTION

AnyLogic simulation software was chosen due to its agent-based modeling capability. The team put the description of the supply chain into the model, and defined the following as interacting agents with their own goals and rules, individual behavior, and interaction policies:

- **Distribution centers** (location, number of units, overhead cost, startup cost)
- **Customers, or wholesalers** (location, demand rate, total shipments, distance, shipment type etc.)
- **Trucks and trains** (location, units, owner, destination)
- **Producers** (cotton farmers)
- **Processors** (yarn mills)

With AnyLogic, it was easy to test multiple scenarios and their variations. The input data (number of DC, suppliers, etc.) was different for each variation.

The team found advantages of applying simulation at different stages. It enabled abstraction, simplifying a complex system by focusing on relevant details and estimating them.

When building the model, the team first looked at shipment data, focusing on the locations of high demand customers, as they made up 85% of all the company's shipments. These distributors used truckloads and rails. The team also considered shipments the customer received per year and the demand per shipment in units per customer. Last year demand indicators were used as model input.

To estimate and visualize the existing transportation routes, the team used AnyLogic GIS capabilities, which linked the agents of the model to their locations. The company's head DC was located in the south-east US. From there, the cargo was distributed to wholesalers directly or via transit DCs. This could be a reason for additional transportation costs, which is why the team estimated an optimal location for new DC regarding the wholesalers' disposition. For this purpose, the developers conducted supply chain Greenfield analysis. This experiment is available at anyLogistix, the multimethod software for supply network optimization, design, and analysis.

Scenario #1 included the original DC and outlier customers, and did not show shipping cost reductions regarding products distributed from the DC.

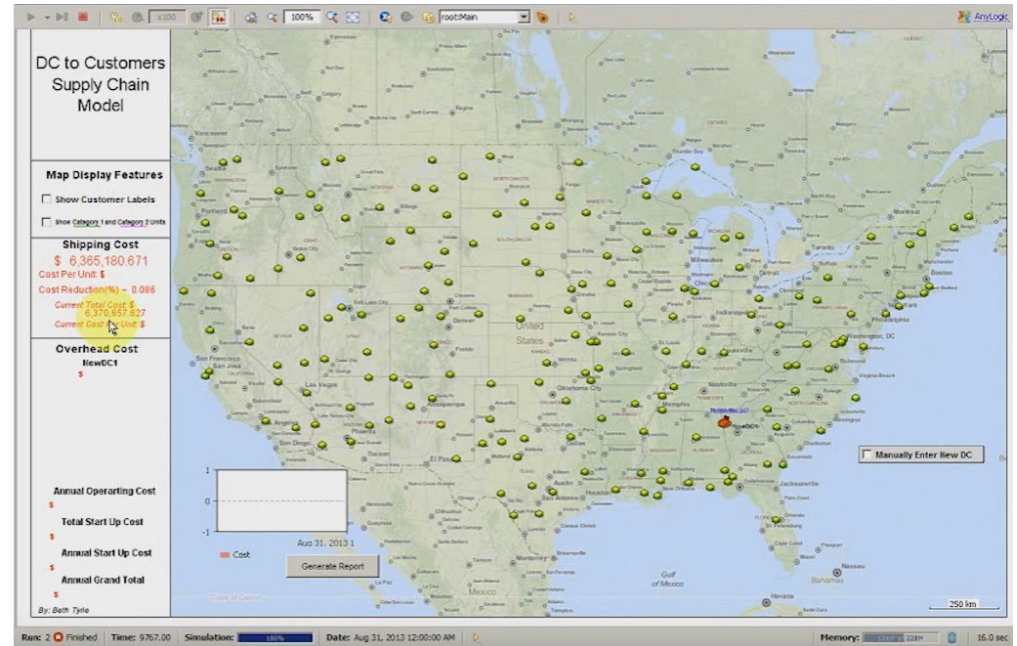
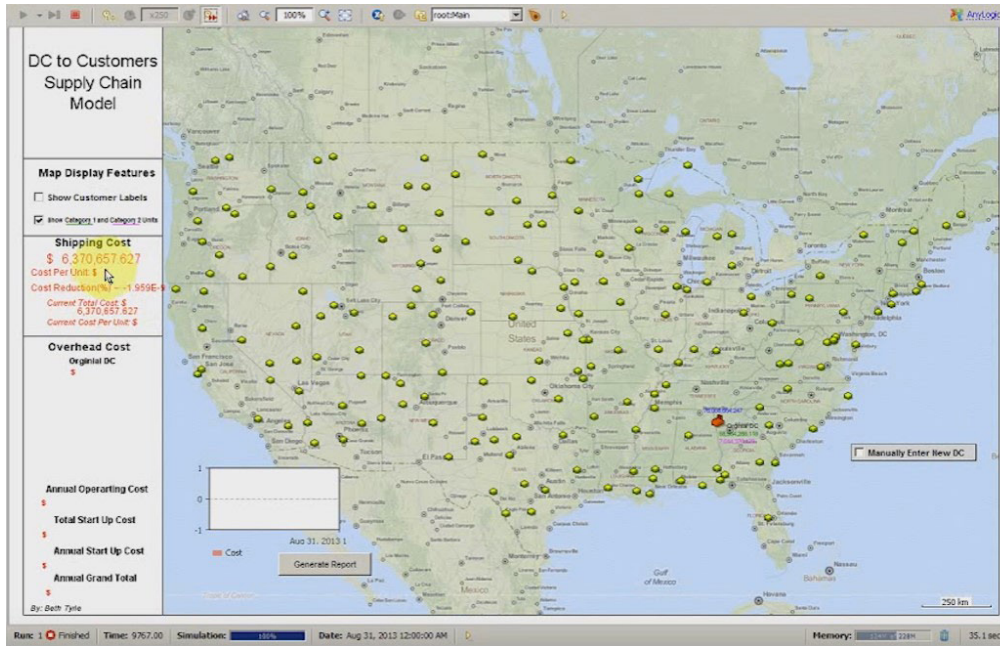

In **Scenario #2**, the original DC was used, rerouting the shipment to other existing DCs, located on the east and west coasts of the US. The scenario resulted in a 42% cost reduction.

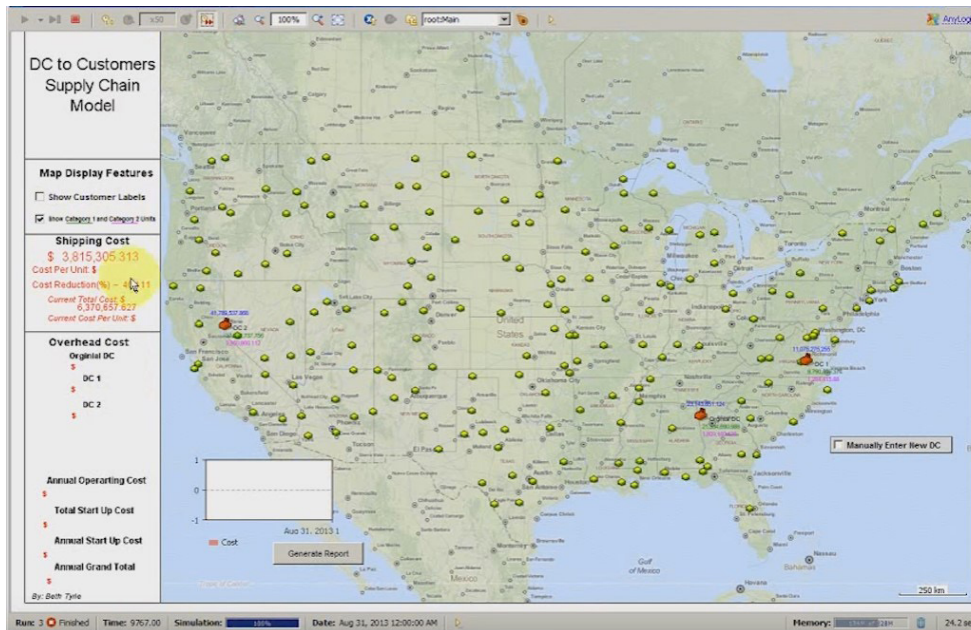

In **Scenario #3**, the network with the original DC was incremented with a new DC in optimal GIS-location. Cost reduction appeared as 32%.

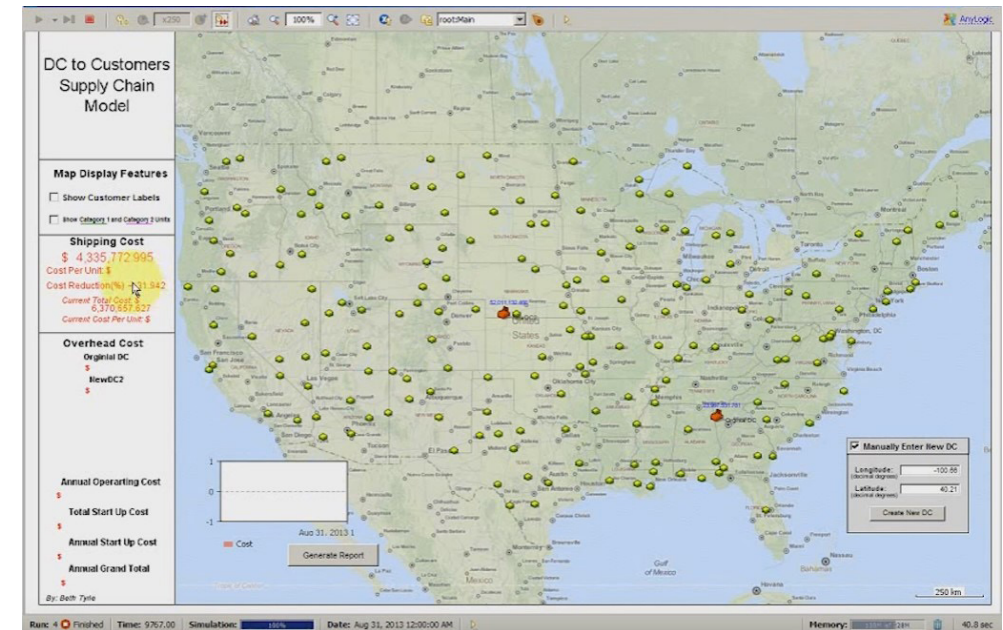

Scenario #4 included the original DC, rerouting products through another already existing DC on the west coast and a new DC in an optimal GIS-location. The scenario's results showed about a 45% cost reduction in the supply chain.

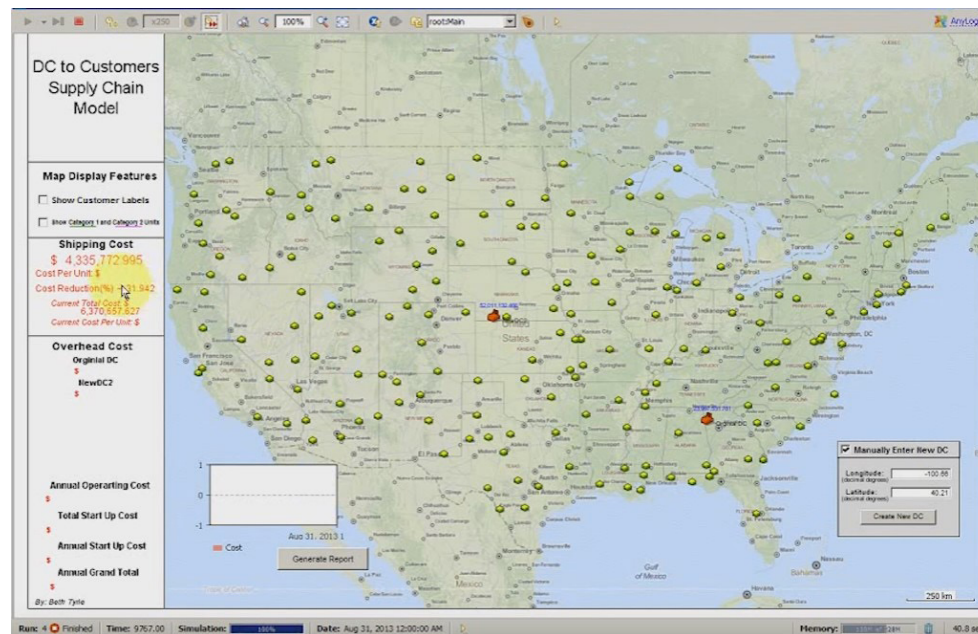

The reports on the model runs for each DC could be exported as an Excel file.

After the experiments, the model was extended with the following agents to adjust for an international supply chain:

- Manufacturers

- Additional distribution centers
- Loading ports
- Ports of discharge
- Vessels
- Additional trucks

Then the team could design the whole international supply chain and determine the optimal location of the DC, taking all agents into account.

OUTCOME

While decisions made on people's expertise, without examining the data, may be considered biased, data-driven insights from GIS and AnyLogic, paired with business knowledge, helped develop supply chain recommendations.

For this case, simulation modeling was used as an exploratory research tool to assess the suggestions on placing DCs throughout the country and to prove their economical effectiveness in terms of manufacturing and customer's supply chains.

The developers highly rated AnyLogic user-friendliness, which allowed them to drag and drop the elements and customize, or expand, the model to any conditions, which would benefit Fruit of the Loom's international business.

[Read case study online](#)
[Watch case study presentation video](#)



STREAM

OIL PIPELINE NETWORK DESIGN

19

PROBLEM

One of the largest oil and gas pipeline operators in North America was delivering oil to a client that was not always able to accept the incoming batches. The operator was challenged to quantify the system impacts of deferred downstream deliveries. They also needed to determine whether the existing tankage at upstream oil terminals would be adequate to store the deferred batches. To better understand the system behavior and impacts of the existing problems in the pipeline network design, the company authorized the development of a network simulation model. The project was carried out by the AnyLogic Company and Stream Systems Ltd.

The business objectives of the project were:

- To understand and evaluate the impact of customer decisions (for example, rejecting or accepting the product) on pipeline network behavior.
- To identify and remove bottlenecks in a multi-terminal oil and gas pipeline network to increase system throughput.
- The consultants' task was to create a model that would be flexible enough for the oil and gas pipeline operator to reframe the problem and experiment with the model to solve other challenges.

SOLUTION

The simulation model included terminals, tanks, pipelines, and oil batches. Each batch was designated a route that included the start and

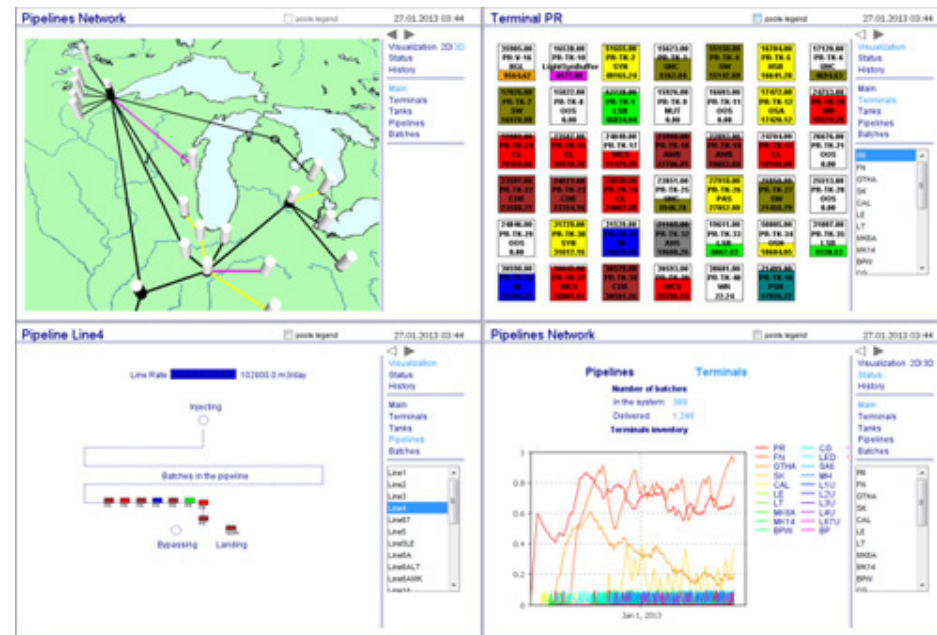

PIPELINE NETWORK DESIGN – SIMULATION MODEL INTERFACE

end terminals. The route could go along different pipeline segments and terminals, and a batch could be temporarily stored in a transit terminal when going through a route.

Oil type compatibility rules were taken into account when there were different types of products in the same pipeline or terminal.

With probability set from the input data, a batch could change its route in one of the transit terminals. Batch movement speed could change because of the lack of free tank capacity in a downstream terminal or equipment breakdowns (reliability information was taken from the input data).

The model output included:

- Batch movement history.
- Terminals' and tanks' used capacity.
- A pipelines' batch movement speed and throughput.

The model also included animation of the pipeline network on a map that visually highlighted the location of each batch and each pipeline's segment status (normal/congested).

OUTCOME

The key performance metrics that were taken into account during model result analysis were: throughput and infrastructure capacity. The company was able to:

- Discover system bottlenecks.
- Evaluate mitigation options (experimenting with the pipeline network by changing rules and design, introducing additional infrastructure elements).
- Assess and measure the effects of changed customer behavior on the network.
- Extend this model by adding additional terminals, pipelines, or tanks.

- Adjust the model to the changing conditions.

The analysis of the experiment results led to an organizational policy change that allowed them to achieve \$50-\$80M in capital savings, and created additional network throughput of \$2M monthly revenue from that point forward. These results were achieved with approximately a \$3M investment, which was a phenomenal outcome.

First, the operators' specialists suggested creating a simulation model at a low level of abstraction. They were familiar with simulating oil movement in pipelines at a molecular level. These models were useful for leak detection, fluid dynamics, and hydraulic problems, but were far too complex to simulate pipeline network behavior.

To do this quickly and easily, and at a desired accuracy and reliability level, they needed to look at the system at a higher level (for example, simulate oil batches, not molecules). Stream Systems' consultants convinced the oil and gas pipeline operator to use AnyLogic to complement this task. Its multimethod modeling features allowed the users to choose the desired abstraction level to solve the challenges of the business.

The created model utilized AnyLogic's multimethod capabilities to the full extent. The model was a combination of all three simulation paradigms: agent-based, system dynamics, and discrete event methods. This allowed the users to save time and effort reproducing the pipeline network design in the model.



[Read case study online](#)

[Watch case study presentation video](#)

ADDITIONAL RESOURCES

| [More Case Studies](#)

| [White Papers](#)

| [Videos](#)

| [Books](#)

| [Download AnyLogic Simulation Software](#)

| [Seminars and Training](#)



CONTACTS

THE ANYLOGIC COMPANY

info@anylogic.com

[Contact your local office >>](#)